

BIGLA30-T Series

Gen III LOV™ Gas Fryer



Installation, Operation and Maintenance Manual

This manual is updated as new information and models are released. Visit our website for the latest manual.

This equipment chapter is to be installed in the Fryer Section of the *Equipment Manual*.



FOR YOUR SAFETY

Do Not Store or use gasoline or other flammable vapors and liquids in the vicinity of this or any other appliance.



READ THE INSTRUCTIONS BEFORE USING THE FRYER.



Part Number: FRY_IOM_8197139 03/2017

Original Instructions



NOTICE

IF, DURING THE WARRANTY PERIOD, THE CUSTOMER USES A PART FOR THIS FRYMASTER EQUIPMENT OTHER THAN AN **UNMODIFIED** NEW OR RECYCLED PART PURCHASED DIRECTLY FROM FRYMASTER DEAN, OR ANY OF ITS AUTHORIZED SERVICERS, AND/OR THE PART BEING USED IS MODIFIED FROM ITS ORIGINAL CONFIGURATION, THIS WARRANTY WILL BE VOID. FURTHER, FRYMASTER DEAN AND ITS AFFILIATES WILL NOT BE LIABLE FOR ANY CLAIMS, DAMAGES OR EXPENSES INCURRED BY THE CUSTOMER WHICH ARISE DIRECTLY OR INDIRECTLY, IN WHOLE OR IN PART, DUE TO THE INSTALLATION OF ANY MODIFIED PART AND/OR PART RECEIVED FROM AN UNAUTHORIZED SERVICER.

NOTICE

This appliance is intended for professional use only and is to be operated by qualified personnel only. A Frymaster DEAN Factory Authorized Servicer (FAS) or other qualified professional should perform installation, maintenance, and repairs. Installation, maintenance, or repairs by unqualified personnel may void the manufacturer's warranty. See Chapter 1 of this manual for definitions of qualified personnel.

NOTICE

This equipment must be installed in accordance with the appropriate national and local codes of the country and/or region in which the appliance is installed. For the United States and Canada these are the National Fuel Gas Code, ANSI Z233.1/NFPA 54, or the Natural Gas and Propane Installation Code, CSA B149.1. See NATIONAL CODE REQUIREMENTS in Chapter 2 of this manual for specifics.

The gas manifold of this appliance or of the battery of which it is a part must be connected to a gas appliance pressure regulator adjusted for the manifold pressure marked on the rating plate.

The appliance and its individual shutoff valve must be disconnected from the gas supply piping system during any pressure testing of that system at test pressures in excess of ½ psi (3.5 kPa/13.84 inches W.C.).

The appliance must be isolated from the gas supply piping system by closing its individual manual shutoff valve during any pressure testing of the gas supply piping system at test pressures equal to or less than ½ psi (3.5 kPa/13.84 inches W.C.).

NOTICE TO U.S. CUSTOMERS

This equipment is to be installed in compliance with the basic plumbing code of the Building Officials and Code Administrators International, Inc. (BOCA) and the Food Service Sanitation Manual of the U.S. Food and Drug Administration.

NOTICE

Drawings and photos used in this manual are intended to illustrate operational, cleaning and technical procedures and may not conform to onsite management operational procedures.

NOTICE

U.S.

This device complies with Part 15 of the FCC rules. Operation is subject to the following two conditions: 1) This device may not cause harmful interference, and 2) This device must accept any interference received, including interference that may cause undesired operation. While this device is a verified Class A device, it has been shown to meet the Class B limits.

CANADA

This digital apparatus does not exceed the Class A or B limits for radio noise emissions as set out by the ICES-003 standard of the Canadian Department of Communications.

 DANGER

Improper installation, adjustment, maintenance or service, and unauthorized alterations or modifications can cause property damage, injury, or death. Read the installation, operating, and service instructions thoroughly before installing or servicing this equipment. Only qualified service personnel may convert this appliance to use a gas other than that for which it was originally configured.

 DANGER

No structural material on the fryer should be altered or removed to accommodate placement of the fryer under a hood. Questions? Call the Frymaster Dean Service Hotline at 1-800-551-8633.

⚠ WARNING

After installation of a gas fryer and after any maintenance to the gas system of a gas fryer-manifold, valve, burners, etc. – check for gas leaks at all connections. Apply a thick soapy solution to all connections and ensure there are no bubbles. There should be no smell of gas.

NOTICE

The Commonwealth of Massachusetts requires any and all gas products to be installed by a licensed plumber or pipe fitter.

⚠ DANGER

Adequate means must be provided to limit the movement of this appliance without depending upon the gas line connectors or associated piping.

All fryers equipped with casters must be stabilized by installing restraining chains. If a flexible gas line is used, an additional restraining cable must be connected at all times when the fryer is in use.

All fryers equipped with casters must be installed using a connector that complies with the Standard for Connectors for Moveable Gas Appliances, ANSI Z21.69 or CSA 6.16, and a quick-disconnect device that complies with the Standard for Quick-Disconnect Devices for Use with Gas Fuel, ANSI Z21.41 or CSA 6.9.

⚠ CAUTION

No warranty is provided for any Frymaster fryer used in a mobile or marine installation or concession. Warranty protection is only offered for fryers installed in accordance with the procedures described in this manual. Mobile, marine or concession conditions of this fryer should be avoided to ensure optimum performance.

⚠ DANGER

The front ledge of the fryer is not a step! Do not stand on the fryer. Serious injury can result from slips or contact with the hot oil.

⚠ DANGER

Do not store or use gasoline or other flammable liquids or vapors in the vicinity of this or any other appliance.

⚠ DANGER

Do not spray aerosols in the vicinity of this appliance while it is in operation.

⚠ DANGER

Instructions to be followed in the event the operator smells gas or otherwise detects a gas leak must be posted in a prominent location. This information can be obtained from the local gas company or gas supplier.

⚠ DANGER

When installed, this appliance must be electrically grounded in accordance with local codes, or in the absence of local codes, with the National Electrical Code, ANSI/NFPA 70, the Canadian Electrical Code, CSA C22.2, or the appropriate national code of the country in which installed.

⚠ DANGER

This product contains chemicals known to the state of California to cause cancer and/or birth defects or other reproductive harm.

Operation, installation, and servicing of this product could expose you to airborne particles of glasswool or ceramic fibers, crystalline silica, and/or carbon monoxide. Inhalation of airborne particles of glasswool or ceramic fibers is known to the State of California to cause cancer. Inhalation of carbon monoxide is known to the State of California to cause birth defects or other reproductive harm.

⚠ DANGER

The crumb tray in fryers equipped with a filter system must be emptied into a fireproof container at the end of frying operations each day. Some food particles can spontaneously combust if left soaking in certain shortening material.

 **WARNING**

Do not bang fry baskets or other utensils on the fryer's joiner strip. The strip is present to seal the joint between the fry vessels. Banging fry baskets on the strip to dislodge shortening will distort the strip, adversely affecting its fit. It is designed for a tight fit and should only be removed for cleaning.

 **WARNING**

To ensure the safe and efficient operation of the fryer and hood, the electrical plug for the 120-volt line, which powers the hood, must be fully engaged and locked in its pin and sleeve socket.

NOTICE

The instructions in this manual for using a bulk oil system for filling and discarding oil are for an RTI and Itto system. These instructions may not be applicable to other bulk oil systems.

NOTICE

This appliance is intended to be used for commercial applications, for example in kitchens of restaurants, canteens, hospitals and in commercial enterprises such as bakeries, butcheries, etc., but not for continuous mass production of food.

NOTICE

The appliance must be installed and used in such a way that any water cannot contact the fat or oil.

 **DANGER**

This appliance must be connected to a power supply having the same voltage and phase as specified on the rating plate located on the inside of the appliance door.

 **WARNING**

Use caution and wear appropriate safety equipment to avoid contact with hot oil or surfaces that may cause severe burns or injury.

 **WARNING**

Do not block the area around the base or under the fryers.

 **WARNING**

This appliance is not intended for use by children under the age of 16 or persons with reduced physical, sensory or mental capabilities, or lack of experience and knowledge, unless they have been given supervision concerning use of the appliance by a person responsible for their safety. Do not allow children to play with this appliance.

 **WARNING**

If the electrical power supply cord is damaged, it must be replaced by a Frymaster Factory Authorized Servicer or a similarly qualified person in order to avoid a hazard.

LOV-T™ GAS WARRANTY STATEMENT

Frymaster, L.L.C. makes the following limited warranties to the original purchaser only for this equipment and replacement parts:

A. WARRANTY PROVISIONS - FRYERS

1. Frymaster L.L.C. warrants all components against defects in material and workmanship for a period of two years.
2. All parts, with the exception of the frypot, O-rings and fuses, are warranted for two years after installation date of fryer.
3. If any parts, except fuses and filter O-rings, become defective during the first year after installation date, Frymaster will also pay straight-time labor costs up to two hours to replace the part, plus up to 100 miles/160 km of travel (50 miles/80 km each way).

B. WARRANTY PROVISIONS - FRYPOTS

1. Frymaster warrants the frypot assembly for fifteen (15) years. First ten (10) years parts and labor. Years eleven (11) through fifteen (15) frypot only. Components attached to the frypot, such as the high-limit, probe, gaskets, seals, ignitors and related fasteners, are also covered by the fifteen year warranty if replacement is necessitated by the frypot replacement. Components that are not part of the frypot assembly, such as the blower, gas valve, micro switches, doors and cabinetry are not covered by the frypot warranty. Leaks due to abuse or from threaded fittings such as probes, sensors, high-limits, drain valves or return piping are not included. If the frypot is found to be defective, Frymaster will replace the frypot, allowing up to the maximum time per the Frymaster time allowance chart hours of straight-time labor plus up to 100 miles/160 km of travel (50 miles/80 km each way) to change the frypot.
2. This warranty is limited to fryers operating on natural or propane (LP) gas. Fryers that operate on manufactured gas (also known as town gas or high-hydrogen gas) have a lifetime frypot warranty, parts only.

C. WARRANTY PROVISIONS – COMBUSTION CHAMBERS

1. Frymaster L.L.C. warrants the combustion chambers against defective material or workmanship for a period of ten years from the original installation date, parts and labor.
2. The combustion chamber consists of the infrared burners and the structural components to mount the burners. This warranty does not cover ancillary components, including the igniter, blower, high-limit thermostat, and temperature probe.
3. This warranty is limited to fryers operating on natural or propane (LP) gas.

E. PARTS RETURN

All defective in-warranty parts must be returned to a Frymaster Authorized Factory Servicer within 60 days for credit. After 60 days, no credit will be allowed.

F. WARRANTY EXCLUSIONS

This warranty does not cover equipment that has been damaged due to misuse, abuse, alteration, or accident such as:

- improper or unauthorized repair (including any frypot which is welded in the field);
- failure to follow proper installation instructions and/or scheduled maintenance procedures as prescribed in your MRC cards. Proof of scheduled maintenance is required to maintain the warranty;
- improper maintenance;
- damage in shipment;
- abnormal use;
- removal, alteration, or obliteration of either the rating plate or the date code on the heating elements;
- operating the frypot without shortening or other liquid in the frypot;
- no fryer will be warranted under the ten-year program for which a proper start-up form has not been received.

This warranty also does not cover:

- transportation or travel over 100 miles/160 km (50 miles/80 km each way), or travel over two hours;
- overtime or holiday charges;
- consequential damages (the cost of repairing or replacing other property which is damaged), loss of time, profits, use or any other incidental damages of any kind.

There are no implied warranties of merchantability or fitness for any particular use or purpose.

This warranty is applicable at the time of this printing and is subject to change.

Table of Contents

	Warranty Statement.....	i
Section 1	Introduction	1-1
Section 2	Installation	2-1
Section 3	Operation Instructions	3-1
Section 4	M4000 Controller Instructions	4-1
Section 5	Filtration Menu Operation.....	5-1
Section 6	Preventative Maintenance	6-1
Section 7	Operator Troubleshooting	7-1
Section D	Itto Solid Shortening Installation Option.....	D-1
Section E	Itto Solid Shortening Melting Unit Use	E-1

BIGLA30-T SERIES GEN III LOV™ GAS FRYER

CHAPTER 1: INTRODUCTION

NOTE: The Frymaster BIGLA30-T fryer requires a start-up, demonstration and training before normal restaurant operations can begin.

1.1 General

Read the instructions in this manual thoroughly before attempting to operate this equipment. This manual covers all configurations of models and BIGLA30-T LOV™ fryers. Models designated BIGLA30-T are equipped with FootPrint Pro built-in filtration systems. The fryers in this model family have most parts in common, and when discussed as a group, will be referred to as “LOV™ fryers.

Although similar in appearance to the BIPH55 McDonald’s fryers, the BIGLA30-T LOV™ fryers feature a low oil volume frypot, auto top-off, automatic intermittent filtration and a touch screen. The Euro-Look design incorporates a rounded topcap and a large round drain which ensures that fries and other debris will be washed into the filter pan. The BIGLA30-T LOV™ fryers are controlled with an M4000 touchscreen controller. Fryers in this series come in full- or split-vat arrangements, and can be purchased in batteries of up to five vats.

LOV™ high-efficiency gas fryers employ a unique infrared burner system that uses up to 43% less energy to cook the same volume as conventional open-burner fryers.

LOV™ gas fryers are of an open-frypot design with no tubes, which makes cleaning the stainless frypot quick and easy.

Heating is supplied by a pair of infrared burner assemblies mounted on each side of the frypot. A dedicated blower mounted on the front of the frypot supplies combustion air for the burners. LOV™ Gas fryers can be configured for natural gas, propane (LP), or manufactured gas, as required by the customer.

Each frypot is equipped with a temperature probe for precise temperature control.

All fryers in this series require an external source of AC electrical power. Units can be configured for voltages ranging from 100 VAC to 250 VAC.

BIGLA30-T LOV™ fryers are shipped completely assembled. All fryers are shipped with a package of standard accessories. Each fryer is adjusted, tested, and inspected at the factory before crating for shipment.

This appliance is only for professional use and shall be used by qualified personnel only, as defined in Section 1.6.

1.2 Safety Information

Before attempting to operate your unit, read the instructions in this manual thoroughly. Throughout this manual, you will find notations enclosed in double-bordered boxes similar to the ones that follow.

 **CAUTION**

CAUTION boxes contain information about actions or conditions that *may cause or result in a malfunction of your system.*

 **WARNING**

WARNING boxes contain information about actions or conditions that *may cause or result in damage to your system*, and which may cause your system to malfunction.

 **DANGER**

DANGER boxes contain information about actions or conditions that *may cause or result in injury to personnel*, and which may cause damage to your system and/or cause your system to malfunction.

Your fryer is equipped with automatic safety features:

1. High-temperature detection shuts off gas to the burner assembly should the controlling thermostat fail.
2. A safety circuit on units with filter systems prevents burner ignition with the drain valve open.

The controller is equipped with a lithium battery. Replace battery with Panasonic CR2032 3V lithium battery, part number 807-4674 only. Use of another battery may present a risk of fire or explosion. The battery can be purchased from your Factory Authorized Servicer.

 **CAUTION**

Battery may explode if mistreated. Do not recharge, disassemble or dispose of in fire.

1.3 Information for the M4000 Touchscreen Controllers

FCC COMPLIANCE

This equipment has been tested and found to comply with the limits for a Class A digital device, pursuant to Part 15 of the FCC rules. While this device is a verified Class A device, it has been shown to meet the Class B limits. These limits are designed to provide reasonable protection against harmful interference when the equipment is operated in a commercial environment. This equipment generate, uses and can radiate radio frequency energy and, if not installed and used in accordance with the instruction manual, may cause harmful interference to radio communications.

Operation of the equipment in a residential area is likely to cause harmful interference in which case the user will be required to correct the interference at his own expense.

The user is cautioned that any changes or modifications not expressly approved by the party responsible for compliance could void the user's authority to operate the equipment.

If necessary, the user should consult the dealer or an experienced radio and television technician for additional suggestions.

The user may find the following booklet prepared by the Federal Communications Commission helpful: "How to Identify and Resolve Radio-TV Interference Problems". This booklet is available from the U.S. Government Printing Office, Washington, DC 20402, Stock No. 004-000-00345-4.

1.4 European Community (CE) Specific Information

The European Community (CE) has established certain specific standards regarding equipment of this type. Whenever a conflict exists between CE and non-CE standards, the information or instructions concerned are identified by means of shadowed boxes.

1.5 Installation, Operating, and Service Personnel

Operating information for Frymaster equipment has been prepared for use by qualified and/or authorized personnel only, as defined in Section 1.6. **All installation and service on Frymaster equipment must be performed by qualified, certified, licensed, and/or authorized installation or service personnel, as defined in Section 1.6.**

1.6 Definitions

QUALIFIED AND/OR AUTHORIZED OPERATING PERSONNEL

Qualified/authorized operating personnel are those who have carefully read the information in this manual and have familiarized themselves with the equipment functions, or who have had previous experience with the operation of the equipment covered in this manual.

QUALIFIED INSTALLATION PERSONNEL

Qualified installation personnel are individuals, firms, corporations, and/or companies which, either in person or through a representative, are engaged in and are responsible for the installation of gas-fired appliances. Qualified personnel must be experienced in such work, be familiar with all gas precautions involved, and have complied with all requirements of applicable national and local codes.

QUALIFIED SERVICE PERSONNEL

Qualified service personnel are those who are familiar with Frymaster equipment and who have been authorized by Frymaster, L.L.C. to perform service on the equipment. All authorized service personnel are required to be equipped with a complete set of service and parts manuals, and to stock a minimum amount of parts for Frymaster equipment. A list of Frymaster Factory Authorized Servicers (FAS's) is located on the Frymaster website at www.frymaster.com. ***Failure to use qualified service personnel will void the Frymaster warranty on your equipment.***

1.7 Shipping Damage Claim Procedure

Your Frymaster equipment was carefully inspected and packed before leaving the factory. The transportation company assumes full responsibility for safe delivery upon its acceptance of the equipment for transport.

What to do if your equipment arrives damaged:

1. **File a claim for damages immediately**, regardless of the extent of damages.
2. **Inspect for and record all visible loss or damage**, and ensure that this information is noted on the freight bill or express receipt and is signed by the person making the delivery.
3. **Concealed loss or damage** that was unnoticed until the equipment was unpacked should be recorded and reported to the freight company or carrier **immediately** upon discovery. A concealed damage claim must be submitted within 15 days of the date of delivery. Ensure that the shipping container is retained for inspection.

***Frymaster* DOES NOT ASSUME RESPONSIBILITY FOR DAMAGE OR LOSS
INCURRED IN TRANSIT.**

1.8 Parts Ordering and Service Information

For non-routine maintenance or repairs, or for service information, contact your local Frymaster Authorized Servicer (FAS). In order to assist you quickly, the Frymaster Authorized Servicer (FAS) or Service Department representative requires certain information about your equipment. Most of this information is printed on a data plate affixed to the inside of the fryer door. Part numbers are found in the Parts Manual. Parts orders may be placed directly with your local FAS or distributor. A list of Frymaster Factory Authorized Servicers (FAS's) is located on the Frymaster website at www.frymaster.com. If you do not have access to this list, contact the Frymaster Service Department at 1-800-551-8633 or 1-318-865-1711.

Service information may be obtained by contacting your local FAS/Distributor. Service may also be obtained by calling the Frymaster Service Department at 1-800-551-8633 or 1-318-865-1711 or by email at service@frymaster.com. When requesting service or ordering parts, please have the following information ready:

Model Number: _____
Serial Number: _____
Type of Gas or Voltage: _____
Item Part Number: _____
Quantity Needed: _____

In addition to the model number, serial number, and type of gas, please be prepared to describe the nature of the problem and have ready any other information that you think may be helpful in solving your problem.

RETAIN AND STORE THIS MANUAL IN A SAFE PLACE FOR FUTURE USE.

BIGLA30-T SERIES GEN III LOV™ GAS FRYER

CHAPTER 2: INSTALLATION INSTRUCTIONS

2.1 General Installation Requirements

Proper installation is essential for the safe, efficient, trouble-free operation of this appliance.

Qualified, licensed, and/or authorized installation or service personnel, as defined in Section 1.6 of this manual, should perform all installation and service on Frymaster equipment.

Conversion of this appliance from one type of gas to another should only be performed by qualified, licensed, and/or authorized installation or service personnel as defined in Section 1.6 of this manual.

Failure to use qualified, licensed, and/or authorized installation or service personnel (as defined in Section 1.6 of this manual) to install, convert to another gas type or otherwise service this equipment will void the Frymaster warranty and may result in damage to the equipment or injury to personnel.

Where conflicts exist between instructions and information in this manual and local or national codes or regulations, installation and operation shall comply with the codes or regulations in force in the country in which the equipment is installed.

Service may be obtained by contacting your local Frymaster Dean Factory Authorized Servicer.

 **DANGER**

Building codes prohibit a fryer with its open tank of hot oil being installed beside an open flame of any type, including those of broilers and ranges.

Upon arrival, inspect the fryer carefully for visible or concealed damage. (See **Shipping Damage Claim Procedure** in Section 1.7 of this manual.)

2.1.1 Clearance and Ventilation

The fryer(s) must be installed with a 6" (150 mm) clearance at both sides and back when installed adjacent to combustible construction; no clearance is required when installed adjacent to noncombustible construction. A minimum of 24" (600 mm) clearance should be provided at the front of the fryer.

 **WARNING**

Do not block the area around the base or under the fryers.

 **DANGER**

No structural material on the fryer should be altered or removed to accommodate placement of the fryer under a hood. Questions? Call the Frymaster Dean Service Hotline at 1-800-551-8633.

One of the most important considerations of efficient fryer operation is ventilation. Make sure the fryer is installed so that products of combustion are removed efficiently, and that the kitchen ventilation system does not produce drafts that interfere with burner operation.

The fryer flue opening must not be placed close to the intake of the exhaust fan, and the fryer must never have its flue extended in a “chimney” fashion. An extended flue will change the combustion characteristics of the fryer, causing longer recovery time. It also frequently causes delayed ignition. To provide the airflow necessary for good combustion and burner operation, the areas surrounding the fryer front, sides, and rear must be kept clear and unobstructed.

 **DANGER**

This appliance must be installed with sufficient ventilation to prevent the occurrence of unacceptable concentrations of substances harmful to the health of personnel in the room in which it is installed.

Fryers must be installed in an area with an adequate air supply and adequate ventilation. Adequate distances must be maintained from the flue outlet of the fryer to the lower edge of the ventilation filter bank. Filters should be installed at an angle of 45°. Place a drip tray beneath the lowest edge of the filter. For U.S. installation, NFPA standard No. 96 states, “A minimum distance of 18 in. (450 mm) should be maintained between the flue outlet and the lower edge of the grease filter.” *Frymaster recommends that the minimum distance be 24 in. (600 mm) from the flue outlet to the bottom edge of the filter when the appliance consumes more than 120,000 BTU per hour.*

For installations in the United States, information on construction and installation of ventilating hoods can be found in the NFPA standard cited above. A copy of the standard may be obtained from the National Fire Protection Association, Battery March Park, Quincy, MA 02269.

2.1.2 National Code Requirements

The type of gas for which the fryer is equipped is stamped on the data plate attached to the inside of the fryer door. Connect a fryer stamped “NAT” only to natural gas, those stamped “PRO” only to propane gas, and those stamped “MFG” only to manufactured gas.

Installation shall be made with a gas connector that complies with national and local codes, and, where applicable, CE codes. Quick-disconnect devices, if used, shall likewise comply with national, local, and, if applicable, CE codes. In the absence of local codes, installation must conform to the national Fuel Gas Code, ANSI Z223.1/NFPA 54 or the Natural Gas and Propane Installation code, CSA B149.1, as applicable including:

1. The appliance and its individual shutoff valve must be disconnected from the gas supply piping system during any pressure testing of the system at test pressures in excess of ½ psi (3.5 kPa).
2. The appliance must be isolated from the gas supply piping system by closing its individual manual shutoff valve during any pressure testing of the gas supply piping system at test pressures equal to or less than ½ psi (3.5 kPa).

2.1.3 Electrical Grounding Requirements

All electrically operated appliances must be grounded in accordance with all applicable national and local codes, and, where applicable, CE codes. In the absence of local codes, the appliance must be grounded in accordance with National Electrical Code, ANSI/NFPA 70, or the Canadian Electrical Code, CSA C22.2, as applicable. All units (cord connected or permanently connected) should be connected to a grounded power supply system. A wiring diagram is located on the inside of the fryer door. Refer to the rating plate on the inside of the fryer door for proper voltages.

⚠ DANGER

This appliance is equipped with a special (grounding) plug for your protection against electrical shock, and must be plugged directly into a properly grounded receptacle. Do not cut, remove, or otherwise bypass the grounding prong on this plug!

⚠ DANGER

This appliance requires electrical power for operation. Place the gas control valve in the OFF position in case of a prolonged power outage. Do not attempt to operate this appliance during a power outage.

⚠ WARNING

To ensure the safe and efficient operation of the fryer and hood, the electrical plug for the 120-volt line, which powers the hood, must be fully engaged and locked in its pin and sleeve socket.

2.2 Caster Installation

On an appliance with casters; the installation shall be made with a connector that complies with the Standard for Moveable Gas Appliances, ANSI Z21.69 • CSA 6.16, and a quick disconnect device that complies with the Standard for Quick-Disconnect Devices for Use With Gas Fuel, ANSI Z21.41 • CSA 6.9.

The front right caster may be locked with setscrews that may need to be loosened to move into place. Once in place, the caster setscrews can be locked with the caster wheel parallel to the fryer from front to back to ease moving the fryer in and out of the hood for cleaning and preventing the caster from hitting the oil reservoir.

2.3 Pre-Connection Preparations

⚠ DANGER

DO NOT connect this appliance to the gas supply before completing each step in this section.

After the fryer has been positioned under the exhaust hood, ensure the following has been accomplished:

1. Adequate means must be provided to limit the movement of fryers without depending upon the gas line connector and the quick-disconnect device or its associated piping to limit the appliance movement. If a flexible gas hose is used, a restraining cable must be connected at all times when the fryer is in use. The restraining cable and installation instructions are packed with the flexible hose in the accessories box that was shipped with your unit.

⚠ DANGER

The appliance area must be kept free and clear of combustible material at all times.

2. Frymaster recommends that the minimum distance from the flue outlet to the bottom edge of the hood be 24 in. (600 mm) when the appliance consumes more than 120,000 BTU per hour.
3. Test the fryer electrical system:

- a. Plug the fryer electrical cord(s) into a grounded electrical receptacle. **NOTE: To ensure the safe and efficient operation of the fryer and hood, the electrical plug for the 100 volt to120-volt line, which powers the hood, must be fully engaged and locked in its pin and sleeve socket.**
- b. Place the power switch in the **ON** position.
 - For fryers having controllers, verify that the display indicates the controller is on.
 - If the store is equipped with a hood interlock system, the hood exhaust fan should be on. If not, the store hood interlock system is improperly wired and must be corrected.
- c. Place the fryer power switch in the **OFF** position. Verify that the display indicates OFF. The hood exhaust system should be off when all controllers display OFF.
4. Refer to the data plate on the inside of the fryer door to determine if the fryer burner is configured for the proper type of gas before connecting the fryer quick-disconnect device or piping from the gas supply line.
5. Verify the minimum and maximum gas supply pressures for the type of gas to be used in accordance with the accompanying tables and the data plate on the inside of the fryer door.
6. For fryers equipped with a built-in filtration system (BIGLA30-T models) plug the electrical cord(s) into a power receptacle behind the fryer.

Japan Standard for Gas Pressure		
Fryer Model	BIGLA30-T	
Gas Type	13A	Propane (LP)
Incoming Min Pressure WC/kpa/mbar	4/1.00/10.00	9.2/2.30/23.00
Incoming Max Pressure WC/kpa/mbar	10/2.50/25.00	13.2/3.30/33.00
Orifice Size (mm)	3.18	1.95
Number of Orifices	2	2
Burner Manifold Pressure WC/kPa	3.20/0.80	8.25/2.05

(1) mbar = 10,2 mm H₂O

Japan 13A Gas Standard

13A Gas	Tokyo Gas	Toho gas	Osaka gas
CH ₄ (vol%)	89.6	87.3	88.9
C ₂ H ₆ (vol%)	5.62	6.2	6.8
C ₃ H ₈ (vol%)	3.43	5.4	3.1
C ₄ H ₁₀ (vol%)	1.35	1	1.2
C ₅ H ₁₂ (vol%)	0	0	0
N ₂ (vol%)	0	0.1	0
CO ₂ (vol%)	0	0	0
O ₂ (vol%)	0	0	0
Total(vol%)	100	100	100
Heat value(MJ)	45, 43.14	46.04655	45
Pressure(kPa) Min - Max	1-2.5	1-2.5	1-2.5
Density(Air=1)		0.66	0.638

Japan LP Gas Japan Industrial Standard: JIS K 2240

Types	Sub-types	Composition (mol%)				sulfur (Weight %)	Vapor pressure 40°C (Mpa)	Density (15°C) (g/cm ³)	Copper plate corrosion (40°C, 1h)	Main Usage
		Ethane plus ethylene	Propane plus propylene	Butane plus butene	Butadiene					
Type1	1	<=5	>=80	<=20	<=0.5	<=0.0050	<=1.53	0.500 ~0.620	<=1	Household fuel Professional fuel
	2		>=60	<=40						
	3		<=80	>=30						
Type2	1	--	>=90	<10	--	<=0.0050	<=1.55	0.500 ~0.620	<=1	Industrial fuel Industrial raw material Vehicle fuel
	2		>=50	<50						
	3		<90	>50						
	4		<50	<=90						
	4		<=10	<=90			<=0.52			

The Japan standard for liquefied petroleum gas

Name	Of propane and propylene The total amount of content	Ethane and ethylene The total amount of content	The content of butadiene	Equivalent JIS standard
Accused liquefied petroleum gas	More than 80%	Less than 5%	Less than 0.5%	One No. 1
Filtration issue liquefied petroleum gas	More than 60%, less than 80 percent	Less than 5%	Less than 0.5%	One No. 2
Tooth No. liquefied petroleum gas	Less than 60%	Less than 5%	Less than 0.5%	One No. 3

2.4 Connection to Gas Line

⚠ DANGER

Before connecting new pipe to this appliance, the pipe must be blown out thoroughly to remove all foreign material. Foreign material in the burner and gas controls will cause improper and dangerous operation.

⚠ DANGER

The appliance and its individual shutoff valve must be disconnected from the gas supply piping system during any pressure testing of the system at test pressures in excess of ½ PSI (3.45 kPa, 13.84 inches W.C.) to avoid damage to the fryer's gas tubes and gas valve(s).

⚠ DANGER

The appliance must be isolated from the gas supply piping system by closing its individual manual shutoff valve during any pressure testing of the gas supply piping system at test pressures equal to or less than ½ PSI (3.45 kPa, 13.84 inches W.C.)

⚠ DANGER

“Dry-firing” your unit will cause damage to the frypot and can cause a fire. Always ensure that cooking oil or water is in the frypot before firing the unit.

⚠ DANGER

All connections must be sealed with a joint compound suitable for the gas being used and all connections must be tested with a solution of soapy water before lighting any pilots.

Never use matches, candles, or any other ignition source to check for leaks. If gas odors are detected, shut off the gas supply to the appliance at the main shut-off valve and immediately contact the local gas company or an authorized service agency for service.

The size of the gas line used for installation is very important. If the line is too small, the gas pressure at the burner manifold will be low. This may cause slow recovery and delayed ignition. The incoming gas supply line should be a minimum of 1½” (38 mm) in diameter. Refer to the chart below for the minimum sizes of connection piping.

Gas Connection Pipe Sizes			
(Minimum incoming pipe size should be 1 1/2" (41 mm))			
Gas	Single Unit	2 - 3 Units	4 or more units*
Natural	3/4" (22 mm)	1" (28 mm)	1 1/4" (36 mm)
Propane	1/2" (15 mm)	3/4" (22 mm)	1" (28 mm)
Manufactured	1" (28 mm)	1 1/4" (36 mm)	1 1/2" (41 mm)

* For distances of more than 20 feet (6 m) and/or more than 4 fittings or elbows, increase the connection by one pipe size.

NOTICE

The air pressure switch on the combustion blower should read: Full Vat units-122pa (0.5 inches W.C.) and for Split Vat units-180pa (0.72 inches W.C.).

CE Standard

Required airflow for the combustion air supply is 2m³/h per kW.

1. Connect the quick-disconnect hose to the fryer quick-disconnect fitting under the front of the fryer and to the building gas line.

NOTE: Some fryers are configured for a rigid connection to the gas supply line. These units are connected to the gas supply line at the rear of the unit.

When using thread compound, use very small amounts on male threads only. Use a pipe thread compound that is not affected by the chemical action of LP gases (Loctite™ PST56765 Sealant is one such compound).

DO NOT apply compound to the first two threads. Doing so may allow some of the compound to enter the gas stream, resulting in clogging of burner orifices and/or the control valve.

2. Open the gas supply to the fryer and check all piping, fittings, and gas connections for leaks. A soap solution should be used for this purpose.
3. Light the fryer following the procedures that are described in the “Lighting Instructions” found in Chapter 3 of this manual.

 **DANGER**

“Dry-firing” your unit will cause damage to the frypot and can cause a fire. Always ensure that cooking oil or water is in the frypot before firing your unit.

4. The burner manifold pressure should be checked at this time by the local gas company or an authorized service agent. The tables on page 2-4 list the burner manifold gas pressures for the various gas types that can be used with this equipment. Also verify the pressures, on the rating plate, inside the fryer door
5. Check the programmed temperature thermostat setting by pressing the temperature button.

2.5 Converting to Another Gas Type

 **DANGER**

This appliance was configured at the factory for a specific type of gas. Converting from one type of gas to another requires the installation of specific gas-conversion components. Conversion instructions are included with conversion kits.

Switching to a different type of gas without installing the proper conversion components may result in fire or explosion. NEVER ATTACH THIS APPLIANCE TO A GAS SUPPLY FOR WHICH IT IS NOT CONFIGURED!

Conversion of this appliance from one type of gas to another should only be performed by qualified, licensed, and authorized installation or service personnel, as defined in Section 1.6 of this manual.

BIGLA30-T LOV™ gas fryers manufactured for Non-CE countries use different burners for each type gas. The burners in fryers built for propane gas have a special gray-colored coating on the burner tiles to enable them to withstand the higher caloric value of the propane gas. Burners designed for use in propane units may be used in natural gas applications, but not vice versa.

Non-CE Gas Conversion Kits for Japan	
Natural Gas to Propane (LP) Gas	Propane (LP) Gas to Natural Gas
Full Vat: PN 826-2969	Full Vat: PN 826-2971
Dual Vat: PN 826-2970	Dual Vat: PN 826-2972

2.6 After Fryers are Positioned at the Frying Station

 **DANGER**

No structural material on the fryer should be altered or removed to accommodate placement of the fryer under a hood. Questions? Call the Frymaster Dean Service Hotline at 1-800-551-8633.

1. Once the fryer has been positioned at the frying station, use a carpenter's level placed across the top of the frypot to verify that the unit is level, both side-to-side and front-to-back.

To level fryers, adjust the casters being careful to ensure the fryer(s) are at the proper height in the frying station.

When the fryer is leveled in its final position, install the restraints provided by the KES to limit its movement so that it does not depend on or transmit stress to the connection. Install the restraints in accordance with the provided instructions. If the restraints are disconnected for service or other reasons, they must be reconnected before the fryer is used.

⚠ DANGER

Hot oil can cause severe burns. Avoid contact. Under all circumstances, oil must be removed from the fryer before attempting to move it to avoid spills, falls, and severe burns. Fryers may tip and cause personal injury if not secured in a stationary position.

⚠ DANGER

Adequate means must be provided to limit the movement of this appliance without depending on the connector and the quick-disconnect device or its associated piping to limit the appliance movement.

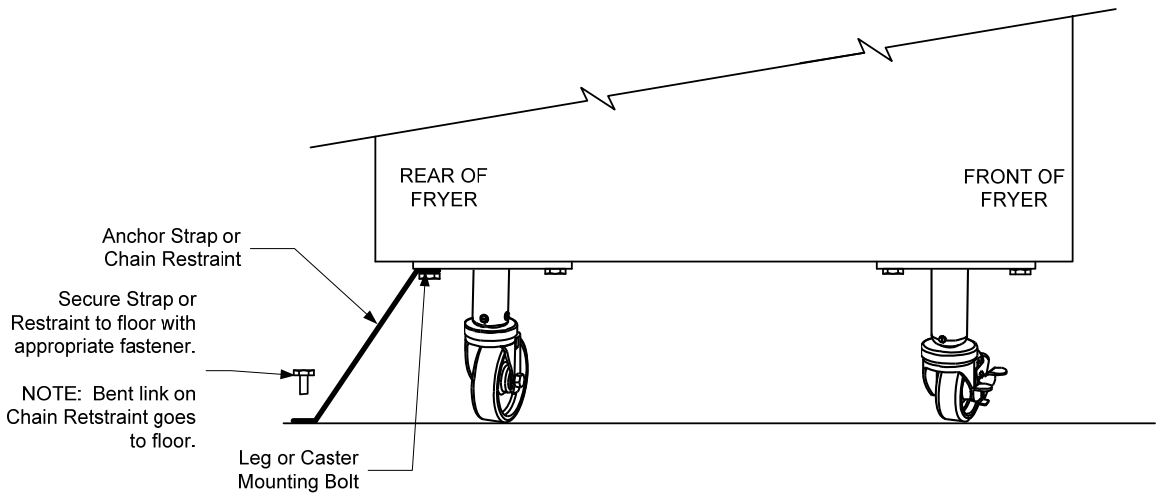

2. Clean, and fill frypot(s) with cooking oil. (See *Equipment Setup and Shutdown Procedures* in Chapter 3.)

BIGLA30-T SERIES GEN III LOV™ GAS FRYER

CHAPTER 3: OPERATING INSTRUCTIONS

FINDING YOUR WAY AROUND THE BIGLA30-T SERIES LOV™ GAS FRYER

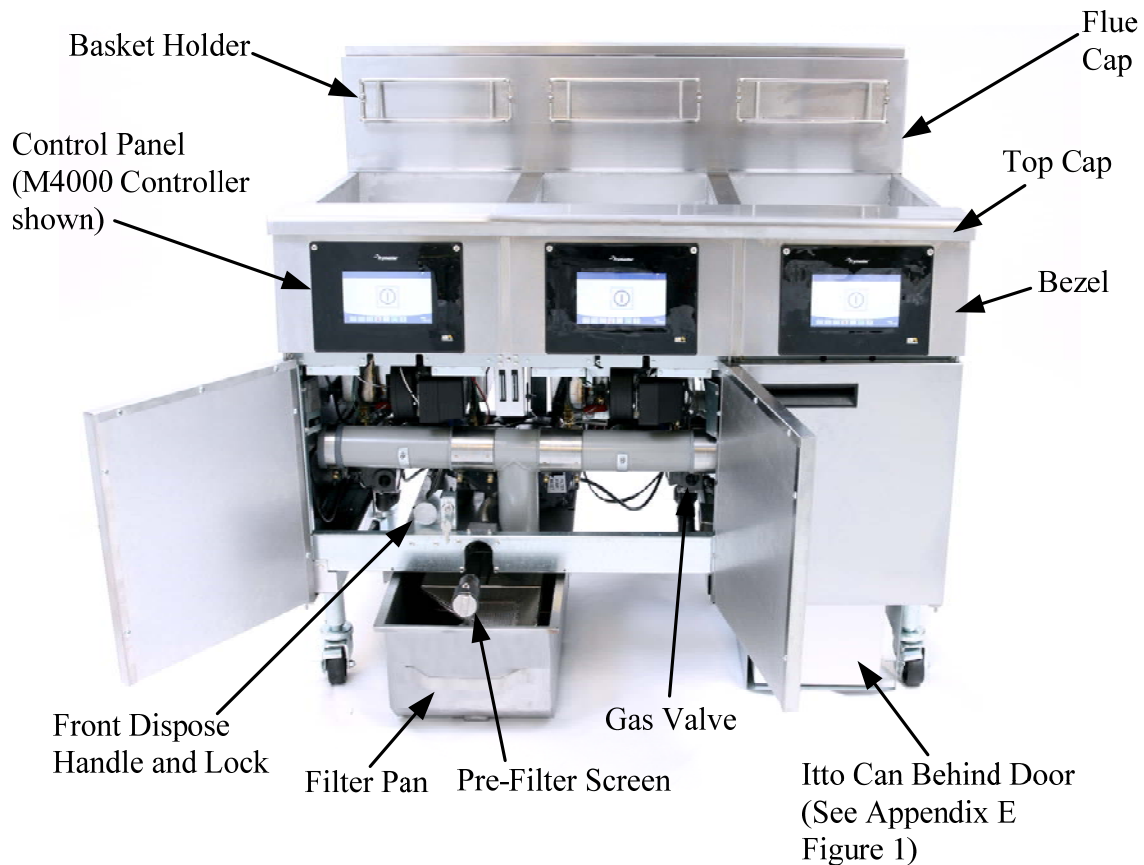

TYPICAL CONFIGURATION (BIGLA330-T SHOWN)

NOTE: The appearance of your fryer may differ slightly from that shown depending upon configuration and date of manufacture.

3.1 Equipment Setup and Shutdown Procedures

⚠ WARNING

The on-site supervisor is responsible for ensuring that operators are made aware of the inherent hazards of operating a hot oil filtering system, particularly the aspects of oil filtration, draining and cleaning procedures.

⚠ CAUTION

Before lighting the fryer, make sure the fryer is OFF and the frypot drain valves are closed. Remove the basket support rack(s), if installed, and fill the frypot to the bottom OIL-LEVEL line. If solid shortening is being used, make sure it is packed down into the bottom of the frypot.

3.1.1 Setup

⚠ WARNING

Never operate this appliance with an empty frypot. The frypot must be filled with water or oil before lighting the burners. Failure to do so will damage the frypot and may cause a fire.

⚠ DANGER

Remove all drops of water from the frypot before filling with oil. Failure to do so will cause spattering of hot liquid when the oil is heated to cooking temperature.

⚠ WARNING

The BIGLA30-T is not intended to use solid shortening without a solid shortening kit installed. The use of solid shortening without a solid shortening kit will clog the top off oil lines. The oil capacity of the BIGLA30-T LOV™ gas fryer is 32 lbs. (3.8 gallons/14.5 liters) at 70°F (21°C) for a full-vat and 18 lbs. (2.2 gallons/8.33 liters) at 70°F (21°C) for each half of a dual-vat.

Prior to filling frypots with oil, ensure all drains are closed.

1. Fill the frypot with cooking oil to the bottom OIL LEVEL line located on the rear of the frypot. This will allow for oil expansion as heat is applied. Do not fill cold oil any higher than the bottom line; overflow may occur as heat expands the oil. If solid shortening is used, make sure it is packed down into the bottom of the frypot.
2. Ensure that the power cord(s) is/are plugged into the appropriate receptacle(s). Verify that the face of the plug is flush with the outlet plate, with no portion of the prongs visible.
3. Ensure that the oil level is at the *top* OIL LEVEL line when the oil *is at its cooking temperature*.

3.1.2 Lighting the Fryer

1. Press the controller ON/OFF switch to the OFF position.

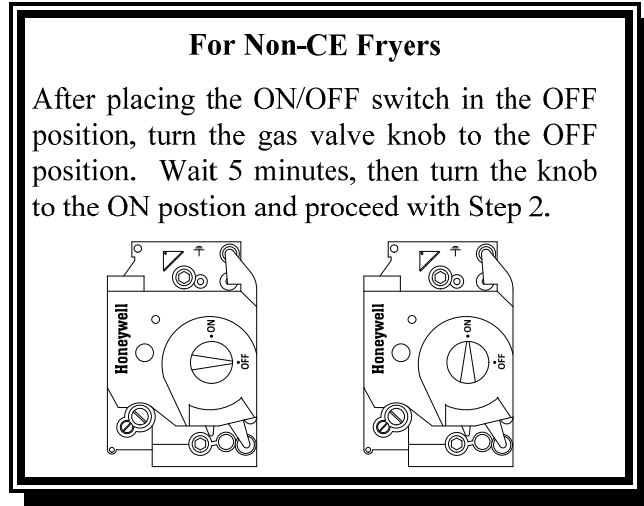

2. Press the controller ON/OFF switch to the ON position.
3. If the burners fail to light, press the ON/OFF switch to the OFF position and wait 60 seconds. Repeat step 2.
4. The fryer will automatically enter the melt cycle mode if the frypot temperature is below 180°F (82°C) and will display MELT CYCLE IN PROGRESS. (**NOTE:** During the melt cycle, the burners will repeatedly fire for a few seconds, then go out for a longer period.) The shortening must be stirred occasionally during the heating process to ensure all the shortening in the drain and vat are liquefied. When the frypot temperature reaches 180°F (82°C), the unit will automatically switch to the heating mode and PREHEAT is displayed until within 15°F (9°C) of setpoint. The burners will remain lit until the frypot temperature reaches the programmed cooking temperature. Once the fryer reaches setpoint, the controller display changes to START and the fryer is ready for use.
5. After the burners have been lit for at least 90 seconds, observe the flames through the burner viewing ports located on each side of the combustion air blower.

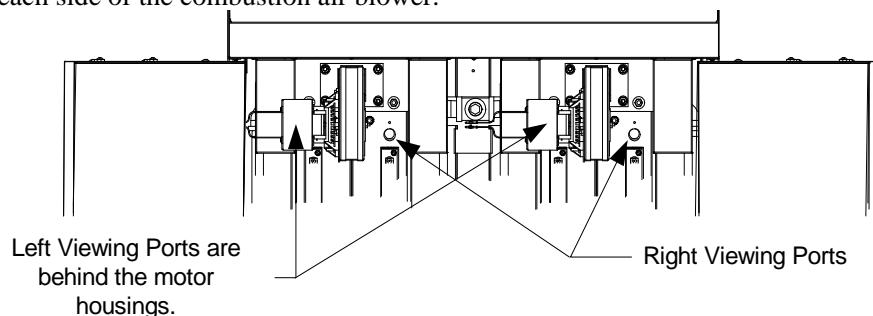

The optimum burn is a bright orange-red glow. If a blue flame is observed, or if there are dark spots on a burner face, adjust the air gas mixture as follows: On the side of the blower housing opposite the motor is a plate with one or two locking nuts. Loosen the nuts enough to allow the plate to be moved, then adjust the position of the plate to open or close the air intake opening until a bright orange-red glow is obtained. Carefully hold the plate in position and tighten the locking nuts.

3.1.3 Shutdown

For short-term shut down during the workday:

1. Place the controller ON/OFF switch in the **OFF** position and put the frypot covers in place.

When shutting the fryers down at closing time:

1. Place the controller ON/OFF switch in the **OFF** position to turn the fryer off.

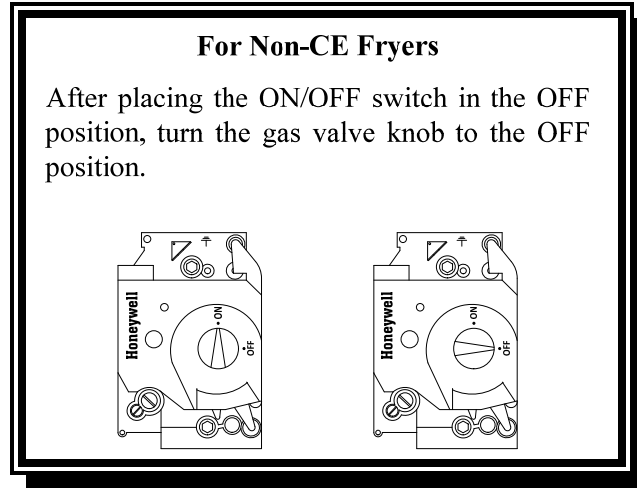

2. Filter the oil and clean the fryers (See Chapters 5 and 6).
3. Clean the filter pan and replace the filter paper. Do not leave solid shortening in the filter pan over night.
4. Place the frypot covers on the frypots.

3.2 Operation

This fryer is equipped with M4000 controllers (illustrated below). Refer to the M4000 *Controller Operating Instructions* in Chapter 4 for the controller programming and operating procedures.



M4000 CONTROLLER

Refer to Chapter 5 of this manual for operating instructions for the built-in filtration system.

3.3 Low Oil Volume Automatic Refill

When the Low Oil Volume (LOV™) system is in place on the fryer, the frypot oil levels are continually checked and topped off as necessary from a reservoir in the cabinet. In a typical operation this will last approximately two days. Components of the system are annotated at the right (see Figure 1).



Reset Switch: Resets the yellow indicator after an oil change.

Figure 1

NOTE: The system is intended to top off the frypots, not fill them. The frypots will require manual filling upon startup and after deep clean (boil-out).

3.4.1 Prepare the System for Use

Once the fryer is positioned under the see Appendices D and E.

3.4.3 Changing the oil reservoir

When the oil reservoir level is low, a yellow indicator is activated (see Figure 3) and displays TOP OFF OIL EMPTY. Press the check button to clear the screen. Once the reservoir is refilled and/or replaced, press and hold the orange reset button (see Figure 3) next to the oil reservoir until the yellow indicator is no longer illuminated. If using solid shortening see Appendix E for instructions.

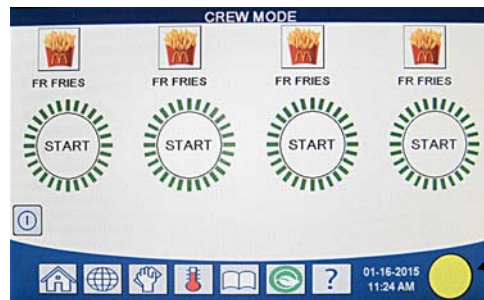

Figure 2

Yellow indicator that oil reservoir is empty.

3.4.4 Bulk or Front Dispose Oil Systems

Instructions for installing front dispose oil systems are found in Appendices D and E located at the rear of this manual.

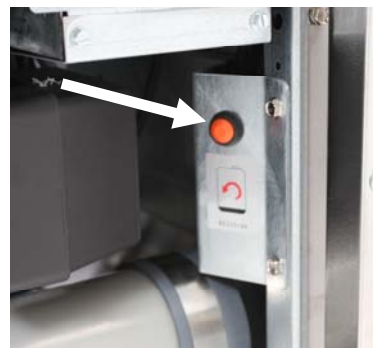

Figure 3

WARNING
Do not add HOT or USED oil to the oil reservoir.

BIGLA30-T SERIES GEN III LOV™ GAS FRYER

CHAPTER 4: M4000 CONTROLLER INSTRUCTIONS

4.1 M4000 General Information

Welcome to the M4000, an easy to use touch screen controller with the utility of 40-product menu capability. One button push starts a cook cycle for a selected product. Just choose a menu item on a product button and press the START button under the display showing the desired item. The controller can move seamlessly from McNuggets to Crispy Chicken to any added menu item.

The M4000 will operate with electric and gas fryers, both full- and split-vat.

4.2 M4000 Button Description and Functions

4.2.1 Navigation Buttons

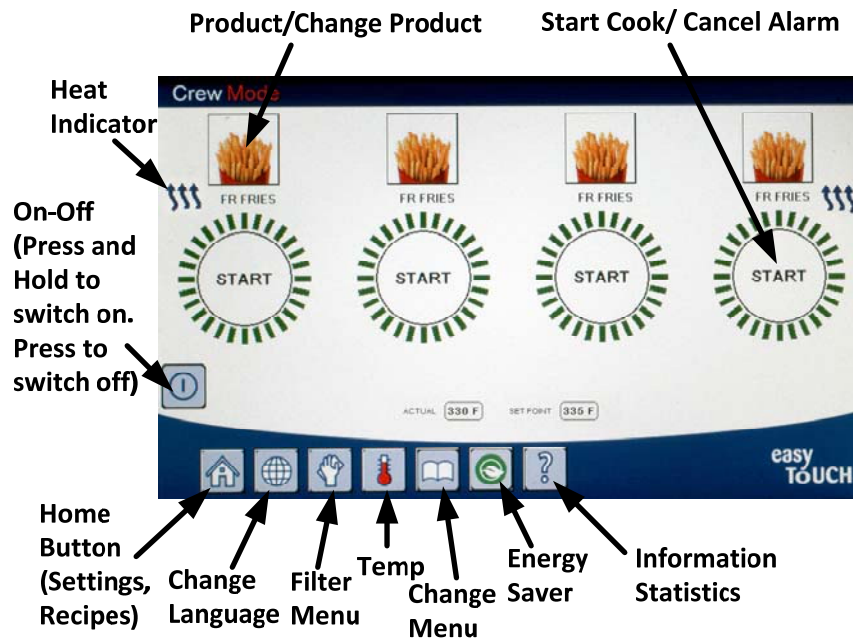

4.2.1.1 Main Menu Button Bar

The main menu button bar at the bottom of the screen is used to navigate the various M4000 menus (see Figure 1).



Figure 1

4.2.1.2 Home Button

The home button is used to switch to the home screen (see Figure 2). The home screen has Crew Mode, Menus, Recipes, Settings and Service buttons.

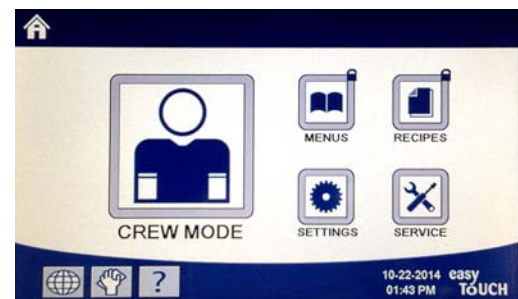

Figure 2

4.2.1.3 Crew Mode Button

The crew mode button switches from the home screen to the cooking mode (see Figure 3).

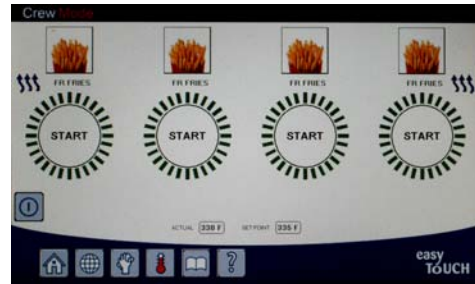

Figure 3

4.2.1.4 Menu Button

The menu button is used to set up multiple menus with specific products such as breakfast, lunch and changeover menus (See Figure 4).

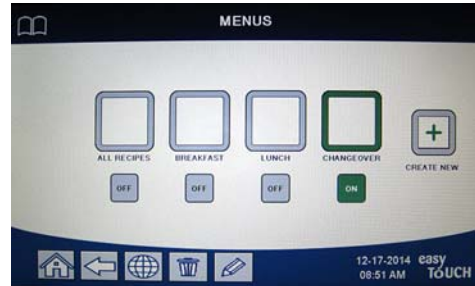

Figure 4

4.2.1.5 Recipes Button

The recipes button allows editing or adding of products (see Figure 5).



Figure 5

4.2.1.6 Settings Button

The settings button allows access to edit the settings of the fryer (see Figure 6).



Figure 6

4.2.1.7 Service Button

The service button allows access to service functions in the fryer (see Figure 7).

During programming and other functions if no activity occurs within one minute, the controller returns to the previous operation mode.

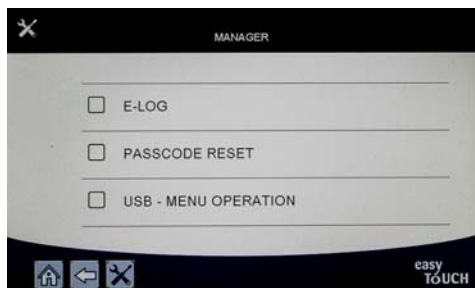

Figure 7

4.2.1.8 Power Button

Pressing and holding the power button soft powers up the user interface and fryer. Pressing the power button when the fryer is on turns the fryer off (see Figure 8).



Figure 8

4.2.1.9 Language Button

Pressing the language button switches between a primary language and a secondary language if the feature is configured in manager settings (see Figure 9).



Figure 9

4.2.1.10 Filter Menu Button

Pressing the filter menu button provides access to the functions associated with filtering, disposing, draining, filling as well as deep cleaning the vats (see Figure 10).



Figure 10

4.2.1.11 Temperature Button

Pressing the temperature button displays the actual vat temperature and the setpoint temperature (see Figure 11).



Figure 11

4.2.1.12 Menu Button

Pressing the menu button allows switching between different menus if configured (see Figure 12).



Figure 12

4.2.1.13 Energy Saver Button

Pressing the energy saver button switches the fryer from a standard setpoint to a lower temperature setpoint when the fryer is idle, to save energy costs (see Figure 13).



Figure 13

4.2.1.14 Information Statistics Button

Pressing the information statistics button provides information on filter statistics, oil statistics, life statistics, usage statistics, recovery time, last load statistics, and software versions (see Figure 14).



Figure 14

4.2.1.15 Escape Menu Items

To escape or back out of MENUS and SUB-MENUS, press the Home or Back arrow button (see Figure 15).



Figure 15













4.3 M4000 Menu Summary Tree

Reflected below are the major programming sections in the M4000 and the order in which submenu headings will be found under the sections in the Installation and Operation Manual.



Filtration Menu

- Auto Filtration
- Maintenance Filter
- Dispose Oil
- Drain Oil
- Fill Vat from Drain Pan
- Fill Vat from Bulk (Bulk Only)
- Oil Pan to Waste (Bulk Only)
- Deep Clean

Home Button

- Crew Mode (Cooking Mode) 
- Menus (1234) 
 - Create New
- Recipes (1234) 
 - Product Name
 - Temp 
 - Cook Time 
 - Load Size 
 - Quality Timer 
 - Shake 1 
 - Shake 2 
 - Filter 
- Settings 
 - Manager (1234) 
 - Language
 - Primary
 - Secondary
 - Date & Time
 - F° to C° / C° to F° (Toggles Temperature Scale)
 - Sound
 - Volume
 - Tone
 - Filter Attributes
 - Filter After (Cooks)
 - Filter Time (Hours)
 - Filter Lockout
 - Filtration Lockout Time
 - Energy Savings (Enabled, Temperature, Time)
 - Lane Assignments (# of Baskets)
 - Brightness
 - Screen Saver
 - Service (1650) 
 - Locale (CE / Non-CE)
 - Energy Type (Gas / Electric)
 - Vat Type (Full / Split)
 - Basket Configuration
 - Oil System Type (JIB / Bulk)
 - Waste Oil (None / Bulk/Front Dispose)
 - Auto Top Off Vat (On / Off)
 - ATO Delay Time
 - Filtration Time Settings

Service

- Manager (4321) 
 - E-Log
 - Passcode Setup
 - USB Menu Operation
 - Copy Menu from USB to Fryer
- Crew 
 - Hi-Limit Test

4.4 M4000 Information Summary Tree

Reflected below are the information statistics in the M4000 and the order in which submenu headings will be found in the controller.

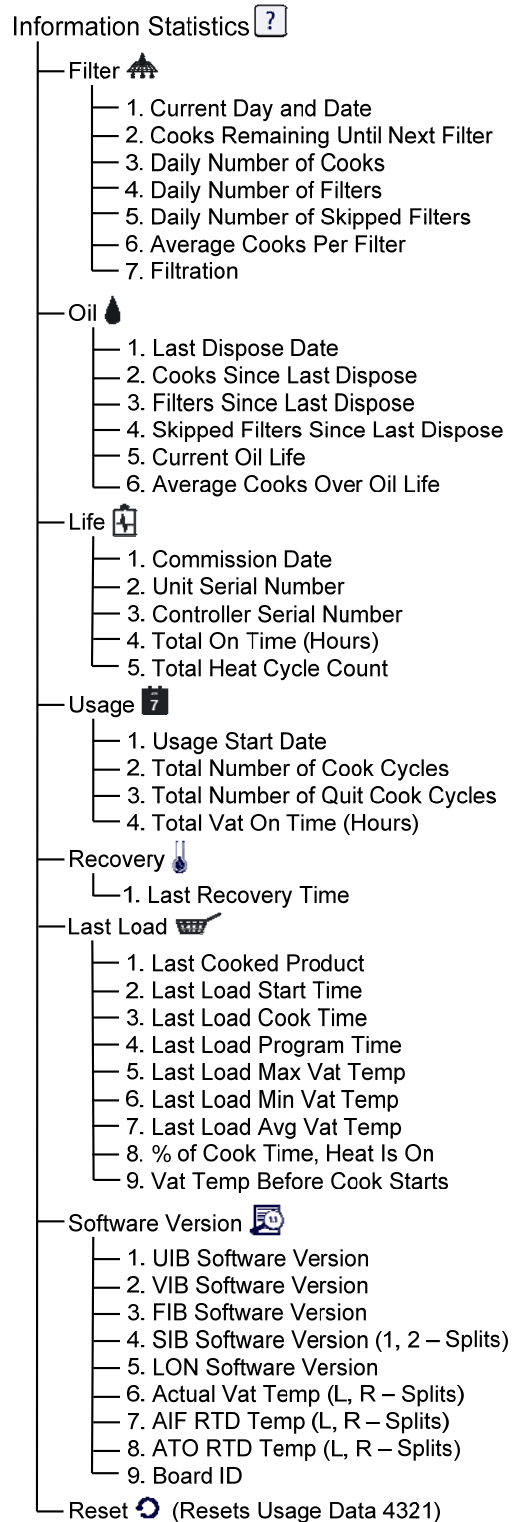

4.5 Basic Operation

M4000 Basic Operation



Turn Fryer ON or OFF

Press and hold button to switch on. Press button to switch off. Select button on desired side of a split vat.



Changing a Product

Press the product ICON associated with the lane to change the product. Then press the new product icon.



Start a Cook Cycle

Press the START button under the desired product.

Cancel a Cook Cycle

Press the RED "X" button next to the desired product within the first 30 seconds of a cook.



Cancel Duty or Shake Alarm

Press button under active display.



Cancel an end of Cook (REMOVE) Alarm

Press button under active display.

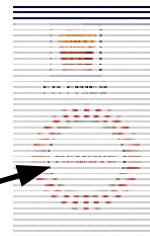

Check Temperature and Setpoint

Press temperature button. Displays actual temperature and setpoint.



Home Button
(Settings, Recipes)

Change Language Filter Menu Temp Menu Energy Saver Information Statistics



4.6 Cooking

Cooking with the M4000

- 1** A product is shown in display. To choose a different product press product icon and choose another product.



- 2** Press the START button under the product to begin the cook cycle.

- 3** Display changes to COOKING with remaining cook time.



- 4** SHAKE alternating with basket is displayed when it is time to shake the fry basket.

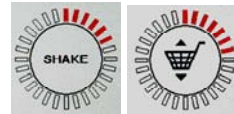

- 5** Press SHAKE/BASKET button to cancel SHAKE alarm.

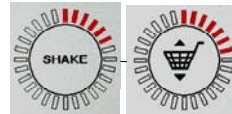

- 6** REMOVE alternating with the CHECKMARK is displayed when the cook cycle is complete.

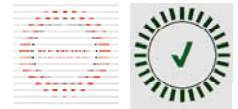

- 7** Press the REMOVE/CHECKMARK button to cancel alarm.



- 8** QUALITY TIMER is displayed below the START button as the quality timer counts down.

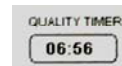

- 9** Pressing the START button now will launch a cook cycle and end the quality countdown timer.



- 10** HOLD EXPIRED alternating with the CHECKMARK is displayed when the quality time has elapsed and expired.

























- 11** Pressing the HOLD EXPIRED/CHECKMARK button restores the display to the current selected product and the unit is ready for cooking.



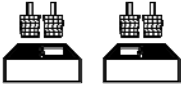

4.7 Fryer (Service) Setup Programming

It is necessary upon initial power up or when changing out a controller to configure the parameters for the fryer. The setup includes locale, energy type, vat type, fresh oil type, waste oil type and auto top off settings. These settings should **ONLY** be changed by a technician.











DISPLAY	ACTION
 	1. With the controller at the off/standby position, press the Home button.
	2. Press the Settings button.
	3. Press the Service button.
1 6 5 0	4. Enter 1650
	5. Press the √ (check) button.
<input type="checkbox"/> LOCALE	6. Press the Locale button.
CE NON-CE	7. Select CE or NON-CE . CE (European Conformity standards) or Non-CE (non-European standards)
SETUP COMPLETE RESET THE SYSTEM	8. No action.
	9. Press the √ (check) button.
<input type="checkbox"/> ENERGY TYPE	10. Press the Energy Type button.
GAS ELECTRIC	11. Select GAS or ELECTRIC
SETUP COMPLETE RESET THE SYSTEM	12. No action.
	13. Press the √ (check) button.
<input type="checkbox"/> VAT TYPE	14. Press the Vat Type button.
FULL VAT SPLIT VAT	15. Select FULL VAT or SPLIT VAT .
4	16. Select Basket Configuration. Default is 4 .
   	17. Press the Product icon and choose the desired product. Repeat for other lanes.
	18. Press the Save button when complete.
SETUP COMPLETE RESET THE SYSTEM	19. No action.
	20. Press the √ (check) button.
	21. Press the Down arrow button.
<input type="checkbox"/> OIL SYSTEM TYPE	22. Press the Oil System Type button.
JIB BULK	23. Select JIB or BULK . NOTE: A JIB (Jug in a Box) or BIB (Bag in a Box) is a disposable type oil container. A bulk system has large storage











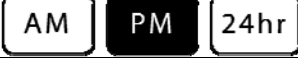

DISPLAY	ACTION
	oil tanks that are connected to the fryer that fills an onboard reservoir.
SETUP COMPLETE RESET THE SYSTEM	24. No action.
	25. Press the √ (check) button.
<input type="checkbox"/> WASTE OIL	26. Press the Waste Oil button.
NONE BULK FRONT DISPOSE	27. Select NONE, BULK or FRONT DISPOSE . NOTE: Select NONE if disposing oil into an MSDU or other METAL container. Select BULK if disposing oil into a bulk oil system, which has large storage oil tanks that are connected to the fryer. Select FRONT DISPOSE if disposing to a front type of disposal (ex. Itto Can).
SETUP COMPLETE RESET THE SYSTEM	28. No action.
	29. Press the √ (check) button.
<input type="checkbox"/> AUTO TOP OFF VAT	30. Press the Auto Top Off Vat button.
	31. Select LEFT VAT or RIGHT VAT for split vats.
ON OFF	32. Select ON unless top off is not desired for this vat. Default is ON .
	33. Press the Down arrow button.
<input type="checkbox"/> ATO DELAY TIME	34. Press the ATO Delay time button.
30 MINUTES 	35. Press the time to change the delay time after the top off oil reservoir has been changed before the system begins to top off. Press the √ (check) button. Enter a value greater than 0 for solid shortening. The default is 30 minutes to allow time for the shortening to start melting before top off begins. Set the value to 0 for liquid shortening.
SETUP COMPLETE	36. No action.
	37. Press the smaller √ (check) button inside the SETUP COMPLETE box.
<input type="checkbox"/> FILTRATION TIME SETTINGS	38. Press the Filtration Time Settings button.
<input type="checkbox"/> POLISH TIME <input type="checkbox"/> DEEP CLEAN TIME <input type="checkbox"/> AUTO FILTER WASH TIME <input type="checkbox"/> MAINTENANCE FILTER WASH TIME 	39. These settings should only be adjusted if instructed by the factory. The default settings are: <input type="checkbox"/> POLISH TIME -300 <input type="checkbox"/> DEEP CLEAN TIME -3600 <input type="checkbox"/> AUTO FILTER WASH TIME -5 <input type="checkbox"/> MAINTENANCE FILTER WASH TIME -30 Press the back button when complete.
	40. Press the Home button.
 CREW MODE	41. Press the Crew Mode button.















DISPLAY	ACTION
	42. Press and hold the reset switch inside the left door for thirty (30) seconds.
	43. The system reboots in approximately 45 seconds and returns to off/standby mode.















4.8 Fryer (Manager) Settings Programming













It is necessary upon initial power up or when changing out a controller to configure these local manager settings for the fryer. The setup includes language, date and time, temperature scale, sound settings, filter settings, energy savings, lane assignments and screen brightness. These settings should ONLY be changed by a manager or technician.

DISPLAY	ACTION
	1. With the controller at the off/standby position, press the Home button.
	2. Press the Settings button.
	3. Press the Manager button.
1 2 3 4	4. Enter 1234
	5. Press the ✓ (check) button.
<input type="checkbox"/> LANGUAGE	6. Press the Language button.
	7. Press the Primary Language button.
<input type="checkbox"/> ENGLISH	8. Select the language desired.
	9. Press the Secondary Language button.
<input type="checkbox"/> KATAKANA	10. Select the language desired.
	11. Press the Back button.
<input type="checkbox"/> DATE & TIME	12. Press the Date & Time button.
	13. Press the Set Time button
	14. Press the hour's box.
	15. Using the key pad, enter the time in hours.
	16. Press the minute's box.

DISPLAY	ACTION
	17. Using the key pad enter the time in minutes.
	18. Press the AM, PM or 24HR button.
	19. Press the √ (check) button.
<p>SETUP COMPLETE</p>	20. No action.
	21. Press the smaller √ (check) button inside the SETUP COMPLETE box.
	22. Press the Set Date button
	23. Press the Date Format box to toggle between MM-DD-YY or DD-MM-YY.
	24. At the top of the screen, the year is shown. Press the left or right arrow to select the year.
	25. Below the year is the month. Press the left or right arrow to select the month.
	26. Select the date using the numbered keys and press the √ (check) button.
<p>SETUP COMPLETE</p>	27. No action.
	28. Press the smaller √ (check) button inside the SETUP COMPLETE box.
	29. Press the DST (DAYLIGHT SAVINGS TIME) SETUP button.
<p><input type="checkbox"/> DST ON/OFF</p>	30. Press the DST ON/OFF button.
	31. Select ON to enable DST or OFF to disable DST.
<p>SETUP COMPLETE</p>	32. No action.
	33. Press the smaller √ (check) button inside the SETUP COMPLETE box.
<p><input type="checkbox"/> DST SETTINGS</p>	34. Press the DST SETTINGS button.
<p><input type="checkbox"/> DST START MONTH <input type="checkbox"/> DST START SUNDAY <input type="checkbox"/> DST END MONTH <input type="checkbox"/> DST END SUNDAY</p>	35. Select any of these and use the keypad to modify. The default settings for the US are: DST START MONTH -3 DST START SUNDAY -2 DST END MONTH -11 DST END SUNDAY -1
	36. Press the √ (check) button when complete.
<p>SETUP COMPLETE</p>	37. No action.













DISPLAY	ACTION
	38. Press the smaller √ (check) button inside the SETUP COMPLETE box.
	39. Press the Back button three (3) times.
<input type="checkbox"/> F° TO C°	40. Press the F° TO C° or F° TO C° button. NOTE: F is used for Fahrenheit, C is used for Celsius
CONFIRM  	41. Select YES to toggle the temperature scale.
COMPLETED SUCCESSFULLY 	42. Press the √ (check) button when complete.
<input type="checkbox"/> SOUND	43. Press the Sound button.
 	44. Use the up down arrows to change the volume level and tone. Volume has nine levels with 1 being the softest and 9 the loudest. Tone has three frequencies from 1-3. Use different frequencies to distinguish protein or French fry stations.
	45. Press the √ (check) button when complete.
SETUP COMPLETE	46. No action.
	47. Press the smaller √ (check) button inside the SETUP COMPLETE box.
	48. Press the Down button.
<input type="checkbox"/> FILTER ATTRIBUTES	49. Press the Filter Attributes button. The auto filtration mode uses two measures before prompting to filter. One checks for cook cycles which is adjusted in the FILTER AFTER setting and the other checks for time which is adjusted in the following section FILTER TIME setting. The prompt for filtration is initiated by whichever occurs first; either the number of cycles elapsed or time elapsed.
<input type="checkbox"/> FILTER AFTER	50. Press the Filter After button. The FILTER AFTER option is used to set the number of cooking cycles which occur before the filtration prompt is displayed.
	51. Press the √ (check) button to continue or press the number button and enter the number of cooks and press the √ (check) button. (By default the full vat is set to 12 cooks and the split vat is set to 6 cooks.)
	52. Press the √ (check) button.
SETUP COMPLETE	53. No action.
	54. Press the smaller √ (check) button inside the SETUP COMPLETE box.
<input type="checkbox"/> FILTER TIME	55. Press the Filter Time button. The Filter Time option is used to set the elapsed time before a filtration prompt. This option is useful in lower volume stores, where filtration is desired more often than the amount the cook cycles would generate.
	56. Press the √ (check) button to continue or press the number button and enter the number of hours in between filter prompts. (ex. after every two hours, enter as 2) and press the √ (check) button. (By default the













DISPLAY	ACTION
	time is set to 0 hours.)
	57. Press the √ (check) button.
SETUP COMPLETE	58. No action.
	59. Press the smaller √ (check) button inside the SETUP COMPLETE box.
<input type="checkbox"/> FILTER LOCKOUT	60. Press the Filter Lockout button. The Filter Lockout option is used to set the times in which the filter prompt is disabled (ex. noon rush).
 	61. Select ON to enable FILTER LOCKOUT. Select OFF to disable FILTER LOCKOUT.
<input type="checkbox"/> FILTRATION LOCKOUT TIME	62. Press the Filter Lockout Time button. The Filtration Lockout Time option is used to set the times in which the filter prompt is disabled (ex. noon rush). NOTE: If FILTER LOCKOUT is disabled (OFF), this option is grayed out and not available.
	63. Use the up down arrows to scroll between M-F 1 thru SUN 4. There are a total of 12 periods which can be programmed for filter prompt lockout. Select the field to edit the start and stop times of when the filter prompt should be suspended. Select AM/PM. Once the times are selected press the check button to save the setting. (The example at the left shows on Monday – Friday no filtering is desired during a lunch rush from 11:00 AM until 1:00 PM.)
	64. Once the times are selected press the √ (check) button.
SETUP COMPLETE	65. No action.
	66. Press the smaller √ (check) button inside the SETUP COMPLETE box.
	67. Press the Back button.
<input type="checkbox"/> ENERGY SAVINGS	68. Press the Energy Savings button. The Energy Savings option is used during idle periods to lower the frypot temperature to save energy.
 	69. Press the Enable button to toggle the Energy Saving option on or off.
	70. Press the Set Back Temp button to change the setpoint of the Energy Saving option. Use the number pad to enter the Energy Saving setpoint temperature and press the √ (check) button.
	71. Press the Idle Time button to change the amount of time in minutes the vat sits idle before automatically entering the Energy Saving mode. Use the number pad to enter the Energy Saving setpoint temperature and press the √ (check) button.
	72. Press the √ (check) button.
SETUP COMPLETE	73. No action.
	74. Press the smaller √ (check) button inside the SETUP COMPLETE box.
<input type="checkbox"/> LANE ASSIGNMENTS	75. Press the Lane Assignments button.













DISPLAY	ACTION
	This is used to set the number of lanes or baskets each vat will use. (Default is 4.)
	76. Press the 4 button.
	77. Press the icon below each lane and choose the associated product to cook in that lane.
	78. Press the save button.
SETUP COMPLETE RESET THE SYSTEM	79. No action.
	80. Press the smaller √ (check) button inside the SETUP COMPLETE RESET THE SYSTEM box.
<input type="checkbox"/> BRIGHTNESS	81. Press the Brightness button. This is used to set the brightness of the screen. Use the up down arrows to adjust. (Default is 100.)
	82. Press the √ (check) button.
SETUP COMPLETE	83. No action.
	84. Press the smaller √ (check) button inside the SETUP COMPLETE box.
<input type="checkbox"/> SCREEN SAVER	85. Press the Screen Saver button. This is used to set the amount of time, after the controller is turned off, before going into a screen saver mode. Use the up down arrows to adjust time. (Default is 15 minutes.)
	86. Use the up down arrows to change the brightness of the screen. Brightness has nine levels with 100 being the brightest and 10 the darkest.
	87. Press the √ (check) button when complete.
SETUP COMPLETE	88. No action.
	89. Press the smaller √ (check) button inside the SETUP COMPLETE box.
	90. Press the Back button.
	91. Press the Home button.
 CREW MODE	92. Press the Crew Mode button.
	93. Press and hold the reset switch inside the left door for thirty (30) seconds.
	94. The system reboots in approximately 45 seconds and returns to off/standby mode.

4.9 Adding or Editing Existing Products

This function is used to add additional products or edit existing products.

DISPLAY	ACTION
	1. Press the Home button.
	2. Press the Recipes button.
1 2 3 4	3. Enter 1234
	4. Press the ✓ (check) button.
	5. Choose the product icon to edit or press the + to add a new product.
	6. Press the pencil icon at the bottom of the screen to edit an existing product.
	7. Enter or change the name of the product using the keyboard.
	8. Press the ✓ (check) button.
	9. This screen displays the current setpoint, cook time, load compensation or sensitivity, quality timer, shake timers and filter settings. To edit a parameter press the item to edit.
	10. To edit temperature press the temp button.
	11. Use the keypad to enter or edit the cook temperature for the product.
	12. Press the ✓ (check) button.
	13. Press the cook time button.











DISPLAY	ACTION
	<p>14. Use the keypad to enter or edit the cook time in minutes and seconds.</p>
	<p>15. Press the ✓ (check) button.</p>
	<p>16. Press the load compensation or sensitivity button.</p>
	<p>17. Use the up and down arrows to change the load compensation or sensitivity setting recommended for this product.</p> <p>This setting allows the product compensation (sensitivity) to be changed. Some menu items may need an adjustment, depending on their cooking characteristics. NOTE: It is highly recommended to NOT adjust this setting, as it could have an adverse effect on the products cooking cycles. The default setting for product compensation is set to four.</p>
	<p>18. Press the ✓ (check) button.</p>
	<p>19. Press the Quality Timer button.</p>
	<p>20. Enter the time in minutes and seconds for the product hold time.</p>
	<p>21. Press the ✓ (check) button.</p>
	<p>22. Press the Shake Timer 1 button.</p>
	<p>23. Enter the time in minutes and seconds for the first shake to be performed.</p>
	<p>24. Press the ✓ (check) button.</p>
	<p>25. Press the down arrow to scroll to more settings.</p>

DISPLAY	ACTION
	<p>26. Press the Shake Timer 2 button if an additional shake is needed, otherwise skip to step 30.</p>
	<p>27. Enter the time in minutes and seconds for the seconds shake to be performed.</p>
	<p>28. Press the ✓ (check) button.</p>
	<p>29. Press the Filter button.</p>
	<p>30. Ensure that the filter button is ON to enable auto filtration for this product. This setting is used to prevent co-mingling of product specific oils. For products such as FISH, select NO to prevent auto filtration.</p>
	<p>31. Press the ✓ (check) button.</p>
	<p>32. Choose the icon to associate with the product recipe that is being entered or edited.</p>
	<p>33. Press the ✓ (check) button.</p>
	<p>34. Choose the menu(s) to associate with the product recipe that is being entered or edited.</p>
	<p>35. Press the ✓ (check) button.</p>
	<p>36. The controller displays SAVED.</p>
	<p>37. Press the ✓ (check) button.</p>
	<p>38. Select another product to edit or press the + key to add additional products. If finished press the home button.</p>

DISPLAY	ACTION
 <p>CREW MODE</p>	<p>39. Press the Crew Mode button to return to main screen.</p>





4.10 Adding or Editing Menus

This function is used to add or edit menus. Menus allow the operator to group certain products together. For example setting up a breakfast menu allows grouping of breakfast only products. This is helpful when switching products by narrowing the amount of products to choose from.

DISPLAY	ACTION
	<p>1. Press the Home button.</p>
	<p>2. Press the Menus button.</p>
<p>1 2 3 4</p>	<p>3. Enter 1234</p>
	<p>4. Press the ✓ (check) button.</p>
	<p>5. Select a menu by pressing the button above the ON/OFF button to edit products (highlighted in green) or press the + button to add a new menu. If adding a new menu, enter name of menu on next screen and press the ✓ (check) button. If deleting a menu, highlight the menu and press the trash can at the bottom of the screen.</p>
	<p>6. Press the pencil icon at the bottom of the screen to edit an existing menu.</p>
	<p>7. Select the desired products by pressing their icons to be added to the chosen menu. The selected products will be highlighted in green. To unselect a product, press the icon and the highlight will change from green to gray.</p>
	<p>8. Press the ✓ (check) button when finished to save selected products to menu.</p>
	<p>9. Press the Back button to edit additional menus starting with step 5, otherwise advance to the next step</p>
	<p>10. Press the Home button.</p>
 <p>CREW MODE</p>	<p>11. Press the Crew Mode button.</p>

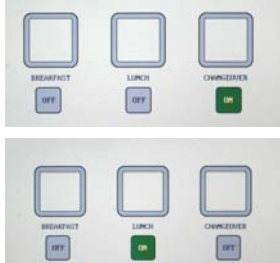
4.11 Changing from Breakfast Menu to Changeover or Lunch Menu





If separate menus are created for Breakfast, Changeover and Lunch, pressing the MENU button from the main screen shall display menu change options. Pressing the desired menu shall switch the menus.

DISPLAY	ACTION
	1. Press the Menu button.
	2. Press the ON/OFF button under Changeover or Lunch to switch menus. NOTE: Only one menu can be selected at a time.
	3. Once the desired menu is selected, “ON” is highlighted under the menu.
	4. Press the back button to return to the main screen.
	5. Press the product icon to switch products.
	6. Display returns to main screen.

4.12 Changing from Lunch Menu to Changeover or Breakfast Menu

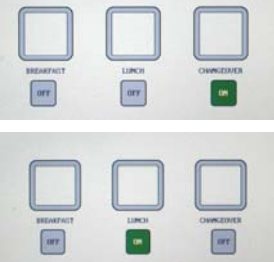
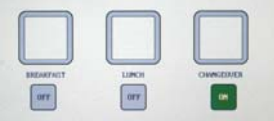
If separate menus are created for Breakfast, Changeover and Lunch, pressing the MENU button from the main screen shall display menu change options. Pressing the desired menu shall switch the menus.

DISPLAY	ACTION
	1. Press the Menu button.

DISPLAY	ACTION
	<p>2. Press the ON/OFF button under Breakfast or Changeover to switch menus.</p> <p>NOTE: Only one menu can be selected at a time.</p>
	<p>3. Once the desired menu is selected, “ON” is highlighted under the menu.</p>
	<p>4. Press the back button to return to the main screen.</p>
	<p>5. Press the product icon to switch products.</p>
	<p>6. Display returns to main screen.</p>



4.13 Service Tasks



Covered in this section are crew and manager service tasks used in stores such as High Limit Test, E-Log (error log), password setup, and functions to copy menus to and from the fryer from USB using menu connect.

4.13.1 High Limit Test

The high-limit test mode is used to test the high limit circuit. The high-limit test will destroy the oil. It should only be performed with old oil. Shut the fryer off and call for service immediately if the temperature reaches 460°F (238°C) without the second high-limit tripping and the controller displays HIGH LIMIT FAILURE DISCONNECT POWER with an alert tone during testing.

The test is cancelled at any time by turning the fryer off. When the fryer is turned back on, it returns to the operating mode and displays the product.

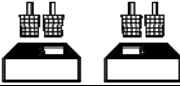
DISPLAY	ACTION
	<p>1. With the controller at the off/standby position, press the Home button.</p>
	<p>2. Press the Service button.</p>





DISPLAY	ACTION
	3. Press the Crew button.
	4. Select LEFT VAT or RIGHT VAT for split vats.
PRESS AND HOLD	5. Press and hold the Press and Hold button to begin high limit test.
RELEASE	6. While pressing and holding the button the vat begins to heat. The controller displays the actual vat temperature during the test. When the temperature reaches 410°F ± 10° F (210°C ± 12°C)*, the controller displays HOT HI-1 (ex. 410F) and continues heating. *NOTE: In controllers used in the European Union (those with the CE mark), the temperature is 395°F (202°C) when the controller displays HOT HI-1.
HOT HI-1	7. While continuing to press and hold the button, the fryer continues heating until the high limit opens. Generally this happens once the temperature reaches 423°F to 447°F (217°C to 231°C) for non-CE high limits and 405°F to 426°F (207°C to 219°C) for CE high limits.
HELP HI-2	8. Release the button. The vat stops heating and the controller displays the current temperature setting until the temperature cools below 400°F (204°C). Press the power button to cancel the alarm.
HIGH LIMIT FAILURE DISCONNECT POWER	9. If the controller displays this message, disconnect power to the fryer and immediately call for service.
	10. After a high limit test, once the vat cools below 400°F (204°C), dispose of the oil.



4.13.2 Manager Functions

4.13.2.1 E-Log

The E-LOG function is used to view the ten (10) most recent error codes encountered on the fryer. These codes are displayed with the most recent errors displayed first. The error code, time and date are displayed.









If no errors exist, the controller is blank in this function. Errors are displayed with the side of the error if a split vat, error code, time and date. An error code displaying an “L” indicates left side of a split vat while an “R” indicates right side of a split vat where the error occurred (R E19 06:34AM 04/22/2014). An error code displaying a “G” indicates this was a global error not specifically linked to a particular vat. Error codes are listed in section 7.6 of this manual.

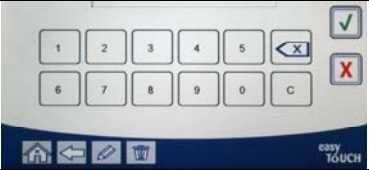

DISPLAY	ACTION
	1. Press the Home button.
	2. Press the Service button.
	3. Press the Manager button.
4 3 2 1	4. Enter 4321
	5. Press the ✓ (check) button.
E-LOG	6. Press the E-LOG button. The three most recent errors are shown.

DISPLAY	ACTION
	7. Press the Down button. The next three errors are shown. Continue pressing the down arrow to view additional errors.
	8. Press the Back button to return to menu or press the Home button to exit.
 CREW MODE	9. Press the Crew Mode button.

4.13.2.2 Passcode Setup





The password mode allows a restaurant manager to change passwords for various modes.

DISPLAY	ACTION
	1. Press the Home button.
	2. Press the Service button.
	3. Press the Manager button.
4 3 2 1	4. Enter 4321
	5. Press the ✓ (check) button.
<input type="checkbox"/> PASSCODE SETUP	6. Press the PASSCODE SETUP button.
<input type="checkbox"/> MENUS <input type="checkbox"/> RECIPES <input type="checkbox"/> SETTINGS MANAGER <input type="checkbox"/> DIAGNOSTICS MANAGER	7. Select the desired passcode to modify. Use the down arrow to scroll to additional setting. Defaults are: MENUS 1234 RECIPES 1234 SETTINGS MANAGER 1234 DIAGNOSTICS MANAGER 4321
	8. Use the keypad to enter new passcode for the selected item.
	9. Press the ✓ (check) button.
RETYPE PASSWORD	10. Use the keypad to enter the new passcode again to verify.
	11. Press the ✓ (check) button.
PASSCODE SETUP SUCCESSFUL 	12. Press the ✓ (check) button.

DISPLAY	ACTION
<input type="checkbox"/> MENUS <input type="checkbox"/> RECIPES <input type="checkbox"/> SETTINGS MANAGER <input type="checkbox"/> DIAGNOSTICS MANAGER  	13. Press the Back button to return to menu or press the Home button to exit.
 CREW MODE	14. Press the Crew Mode button.

4.13.2.3 USB – Menu Operation









This option allows the ability to upload menus to the controller. This allows products to be created in MenuSync to be saved to a USB drive and uploaded to the fryer.

DISPLAY	ACTION
	1. Press the Home button.
	2. Press the Service button.
	3. Press the Manager button.
4 3 2 1	4. Enter 4321
	5. Press the ✓ (check) button.
<input type="checkbox"/> USB – MENU OPERATION	6. Press the USB – MENU OPERATION button.
<input type="checkbox"/> COPY MENU FROM USB TO FRYER	7. Press the COPY MENU FROM USB TO FRYER button.
INSERT USB...	8. Insert the USB drive into the connector behind the far left fryer door.
IS USB INSERTED? YES NO	9. Press YES once the USB drive is inserted.
READING FILE FROM USB PLEASE DO NOT REMOVE USB WHILE READING	10. No action required.
UI-UI MENU DATA TRANSFER IN PROGRESS	11. No action required while the file is loading.
MENU UPGRADE IN PROGRESS	12. No action required while the upgrade is in progress.
UPGRADE COMPLETE? YES	13. Press YES.
MENU UPGRADE COMPLETED, REMOVE THE USB AND RESTART THE SYSTEM.	14. Remove the USB drive and power cycle the entire fryer battery using the reset switch behind the far left fryer door below the USB connector. NOTE: Ensure the switch is pressed and held for at least 30 seconds.

4.14 Information Statistics



4.14.1 Filter Statistics





The filter statistics function is used to view the number of cooks remaining until the next filter, the number of cooks per vat, the number of filters per vat, the number of skipped or bypassed filters per vat and the average number of cook cycles per filter per day.

DISPLAY	ACTION
	1. Press the Information button.
	2. Press the Filter button.
<input type="checkbox"/> DAY 1 <input type="checkbox"/> DAY 2 <input type="checkbox"/> DAY 3 <input type="checkbox"/> DAY 4 	3. Select and press the desired day. Press the down arrow to scroll back additional days.
1. DAY AND DATE (Day and date of filter statistics displayed) 2. COOKS REMAINING UNTIL NEXT FILTER (Number of times cooks that remain until the next filter prompt.) 3. DAILY NUMBER OF COOKS (Number of cooks that day) 4. DAILY NUMBER OF FILTERS (Number of times vat filtered that day) 	4. Press the down arrow to scroll to more statistics.
5. DAILY NUMBER OF SKIPPED FILTERS (Number of times filter was bypassed that day.) 6. AVERAGE COOKS PER FILTER - (Average number of cook cycles per filter that day) 7. FILTRATION – (Displays if filtration is enabled or disabled. Diagnostic tool to determine status of FIB board.)  	5. Press the up arrow to scroll up or the back button to return to select another day.
 	6. Press the back button to return to menu or the home button to exit.

4.14.2 Oil Statistics





The oil statistics function is used to view the date of last dispose, the number of cooks since last dispose, filters since last dispose, skipped filters since last dispose, current oil life and average number of cooks over the oil life.

DISPLAY	ACTION
	1. Press the Information button.
	2. Press the Oil button.

DISPLAY	ACTION
1. LAST DISPOSE DATE 2. COOKS SINCE LAST DISPOSE 3. FILTERS SINCE LAST DISPOSE 4. SKIPPED FILTERS SINCE LAST DISPOSE 	3. Press the down arrow to scroll to more statistics.
5. CURRENT OIL LIFE 6. AVERAGE COOKS OVER OIL LIFE   	4. Press the up arrow to scroll up; the back button to return to menu or the home button to exit.





4.14.3 Life Statistics

The life statistics function is used to view the commission date of the fryer which is automatically set once the fryer has completed 25 cooks, the serial number of the controller, the total time the fryer has operated in hours and the total heat cycle count of the fryer (the amount of times the controller has turned the heat on/off).

DISPLAY	ACTION
	1. Press the Information button.
	2. Press the Life Stats button.
1. COMMISSION DATE 2. UNIT SERIAL NUMBER 3. CONTROLLER SERIAL NUMBER 4. TOTAL ON TIME (HOURS) 5. TOTAL HEAT CYCLE COUNT  	3. Press the back button to return to menu or the home button to exit.





4.14.4 Usage Statistics

The usage statistics displays total cook cycles per vat, number of cook cycles per vat, number of cook cycles exited prior to completion, the number of hours the vat(s) have been on and the date of last usage reset.

DISPLAY	ACTION
	1. Press the Information button.
	2. Press the Usage Stats button.
1. USAGE START DATE 2. TOTAL NUMBER OF COOK CYCLES 3. TOTAL NUMBER OF QUIT COOK CYCLES 4. TOTAL VAT ON TIME (HOURS)  	3. Press the back button to return to menu or the home button to exit.









4.14.5 Recovery Time

Recovery is used to determine if the fryer is operating correctly. Recovery is the time required for the fryer to raise the temperature of the oil 50°F (28°C) between 250°F (121°C) and 300°F (149°C). Maximum recovery time should not exceed 1:40 for electric or 3:15 for gas.

DISPLAY	ACTION
	1. Press the Information button.
	2. Press the Recovery button. The time is displayed in minutes and seconds.
1. LAST RECOVERY TIME  	3. Press the back button to return to menu or the home button to exit.



4.14.6 Last Load Statistics





The last load statistics provides data for the last cook cycle.

DISPLAY	ACTION
	1. Press the Information button.
	2. Press the Last Load button.
1. LAST COOKED PRODUCT 2. LAST LOAD START TIME 3. LAST LOAD COOK TIME 	3. Press the down arrow to scroll to more statistics.
4. LAST LOAD PROGRAM TIME 5. LAST LOAD MAX VAT TEMP 6. LAST LOAD MIN VAT TEMP 7. LAST LOAD AVG VAT TEMP 	4. Press the down arrow to scroll to more statistics.
8. % OF COOK TIME, HEAT IS ON 	
9. VAT TEMP BEFORE COOK STARTS   	5. Press the up arrow to scroll up; the back button to return to menu or the home button to exit.

4.14.7 Software Version







The software version function provides the software versions of the controller and circuit boards in the fryer system; the values of the temperature probe, the AIF RTD probe and the ATO RTD probe.

DISPLAY	ACTION
	1. Press the Information button.
	2. Press the down arrow button.

DISPLAY	ACTION
	3. Press Software Version button.
1. UIB SOFTWARE VERSION 2. VIB SOFTWARE VERSION 3. FIB SOFTWARE VERSION 4. SIB SOFTWARE VERSION 	4. Press the down arrow to scroll to additional software versions and probe temperatures. NOTE: Split vats will have an SIB2 and left and right vat, AIF, and ATO temperatures.
5. LON SOFTWARE VERSION 6. ACTUAL VAT TEMP 7. AIF RTD TEMP 8. ATO RTD TEMP 9. BOARD ID   	5. Press the up arrow to scroll up; the back button to return to menu or the home button to exit.

4.14.8 Reset Usage Statistics

The reset function resets all usage data in the usage statistics.

DISPLAY	ACTION
	1. Press the Information button.
	2. Press the down arrow button.
	3. Press Reset button.
4 3 2 1	4. Enter 4321
	5. Press the √ (check) button.
ALL USAGE DATA HAS BEEN RESET	6. Press the √ (check) button.
  	7. Press the up arrow to scroll up; the back button to return to menu or the home button to exit.

BIGLA30-T SERIES GEN III LOV™ GAS FRYER

CHAPTER 5: FILTRATION MENU INSTRUCTIONS

5.1 Introduction

The FootPrint Pro filtration system allows the oil in one frypot to be safely and efficiently filtered while the other frypots in a battery remain in operation.

Section 5.2 covers preparation of the filter system for use. Operation of the system is covered in Section 5.3.

⚠ WARNING

The on-site supervisor is responsible for ensuring that operators are made aware of the inherent hazards of operating a hot oil filtering system, particularly the aspects of oil filtration, draining and cleaning procedures.

⚠ WARNING

The filter pad or paper **MUST** be replaced daily.

5.2 Preparing the Filter for Use

1. Pull the filter pan out from the cabinet slightly and wait until the dripping stops before completely removing the pan (shown below). Remove the crumb tray, hold-down ring, filter pad or paper, and filter screen (See Figure 1). Clean all metal parts with a solution of All Purpose Concentrate and hot water then dry thoroughly.

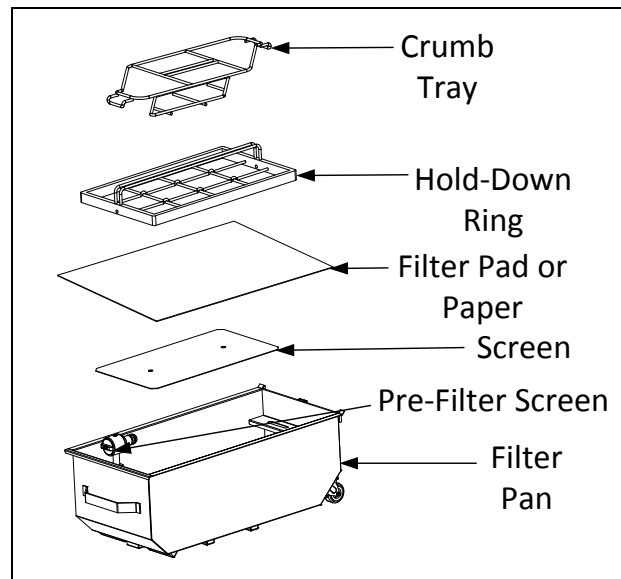

Figure 1

2. Inspect the filter pan connection fitting to ensure that both O-rings are in good condition (See Figure 2). Ensure the pre-filter screen is installed, clean and tight.

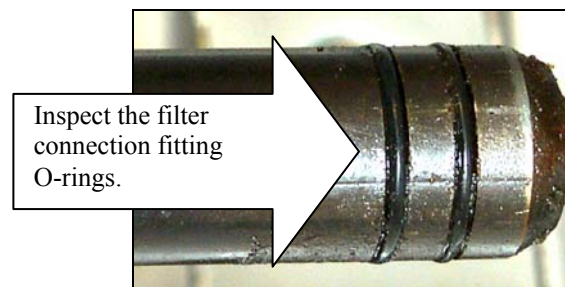

Figure 2

3. Then in reverse order, place the metal filter screen in the center of the bottom of the pan, then lay a filter pad or paper over the screen, ensuring that the **rough** side of the pad is up. Make sure that the pad is in between the embossed ridges of the filter pan. Then position the hold down ring on top of the pad. If using filter paper, lay a sheet of filter paper over the top of the pan overlapping on all sides. Position the hold down ring over the

filter paper and lower the ring into the pan, allowing the paper to fold up and around the ring as it is pushed to the bottom of the pan.

4. Reinstall the crumb tray at the front of the pan. (See Figure 1)
5. Push the filter pan back into the fryer, positioning it under the fryer. Ensure “P” is not displayed in the top right corner of any controller. The filtration system is now ready for use.

⚠ DANGER

Do not drain more than one frypot at a time into the built-in filtration unit to avoid overflow and spillage of hot oil that may cause severe burns, slipping and falling.

⚠ DANGER

The crumb tray in fryers equipped with a filter system must be emptied into a fireproof container at the end of frying operations each day. Some food particles can spontaneously combust if left soaking in certain shortening material.

⚠ WARNING

Do not bang fry baskets or other utensils on the fryer’s joiner strip. The strip is present to seal the joint between the fry vessels. Banging fry baskets on the strip to dislodge shortening will distort the strip, adversely affecting its fit. It is designed for a tight fit and should only be removed for cleaning.

5.3 Filtration Menu

The filtration menu selections are used for filtering, draining, filling, disposing and cleaning the vats.

The filtration menu is listed below:

- Auto Filtration page 5-2
- Maintenance Filter page 5-4
- Dispose Oil (Front Dispose Systems) page 5-9
- Drain Oil page 5-11
- Fill Vat from Drain Pan page 5-12
- Deep Clean (Front Dispose Systems) page 5-20

5.3.1 Auto Filtration

Auto Filtration is a feature that, after a number of preset cook cycles or time, will automatically prompt to filter the frypots. This function can also be performed on demand as well and is covered in the next section. **Note:** Simultaneous filtering of multiple vats does not occur.

DISPLAY	ACTION
FILTRATION REQUIRED - FILTER NOW?	1. Press the √ (check) button to start filtration. If the X button is selected, filtering is cancelled and the fryer resumes normal operation. The controller will prompt again soon to filter the oil. This sequence repeats until a filter is completed.
OIL LEVEL TOO LOW	2. Displayed if the oil level is too low. Press the √ (check) button to acknowledge issue and return to idle cook mode. Check to see if the oil reservoir is low on oil. If oil reservoir is not low and this continues to occur, contact your FAS.
SKIM DEBRIS FROM VAT - PRESS CONFIRM WHEN COMPLETE	3. Skim the crumbs from the oil with a front to back motion, removing as many crumbs as possible from each vat. This is critical to optimizing usable oil life and quality in the oil. Press the √ (check) button when complete.
INSERT PAN	4. Push the filter pan fully into place. Displayed if the filter pan is

DISPLAY	ACTION
	not fully engaged.
DRAINING IN PROGRESS	5. No action required.
WASHING IN PROGRESS	6. No action required.
FILLING IN PROGRESS	7. No action required.
PREHEAT	8. No action required. Displayed until the fryer reaches setpoint.
START	9. Fryer is ready for use. Displayed once fryer reaches setpoint.

The complete filtering process takes roughly four minutes.



If during filtration the oil isn't completely returned the system will proceed to an incomplete filtration function. See section 7.3.1.

NOTE: If during filtration the filter pan is removed, the filtration process stops and resumes once pan is resealed into place.

<p>⚠ DANGER Keep all items out of drains. Closing actuators may cause damage or injury.</p>
--

5.3.2 Auto Demand Filtration

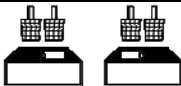
Auto demand filtration is used to manually start an auto filtration. **Note:** Simultaneous filtering of multiple vats does not occur.

DISPLAY	ACTION
	<p>1. The fryer MUST be at setpoint temperature. Press the filtration menu button.</p>
	<p>2. Select LEFT VAT or RIGHT VAT for split vats.</p>
	<p>3. Select AUTO FILTRATION.</p>
<p>AUTO FILTRATION?</p>	<p>4. Press the ✓ (check) button to start filtration. If the X button is selected, filtering is cancelled and the fryer resumes normal operation.</p>

OIL LEVEL TOO LOW	5. Displayed if the oil level is too low. Press the √ (check) button to acknowledge issue and return to idle cook mode. Check to see if the oil reservoir is low on oil. If oil reservoir is not low and this continues to occur, contact your FAS.
SKIM DEBRIS FROM VAT - PRESS CONFIRM WHEN COMPLETE	6. Skim the crumbs from the oil with a front to back motion, removing as many crumbs as possible from each vat. This is critical to optimizing usable oil life and quality of the oil. Press the √ (check) button when complete.
INSERT PAN	7. Push the filter pan fully into place. Displayed if the filter pan is not fully engaged.
DRAINING IN PROGRESS	8. No action required as oil drains into filter pan.
WASHING IN PROGRESS	9. No action required as debris is flushed from the vat.
FILLING IN PROGRESS	10. No action required as the vat refills.
PREHEAT	11. No action required as the fryer heats to setpoint.
START	12. Fryer is ready for use. Displayed once fryer reaches setpoint.

The complete filtering process takes roughly four minutes.

NOTE: If during filtration the filter pan is removed, the filtration process stops and resumes once pan is reseated into place.

⚠ DANGER

Keep all items out of drains. Closing actuators may cause damage or injury.

Should the auto filtration procedure fail an error message is generated. Follow the instructions on the controller to clear the error.

When FILTER BUSY is displayed the FIB board is waiting on another vat to be filtered or waiting on another issue to clear. Press the √ (check) button and wait 15 minutes to see if problem is corrected. If not, call your local FAS.

⚠ DANGER

Do not drain more than one frypot at a time into the built-in filtration unit to avoid overflow and spillage of hot oil that may cause severe burns, slipping and falling.

⚠ WARNING

The filter motor is equipped with a manual reset switch in case the filter motor overheats or an electrical fault occurs. If this switch trips, turn off power to the filter system and allow the pump motor to cool 20 minutes before attempting to reset the switch (see photo on the following page).

⚠ WARNING

Use caution and wear appropriate safety equipment when resetting the filter motor reset switch. Resetting the switch must be accomplished with care to avoid the possibility of a serious burn from careless maneuvering around the drain tube and frypot.

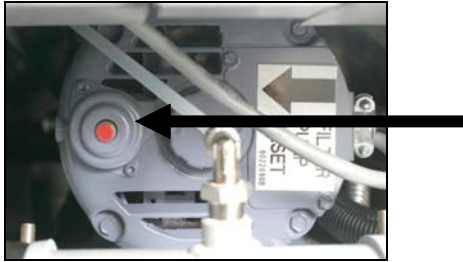

Filter Motor Reset Switch

5.3.3 Maintenance or End of Day Filter

Ensure that the filter pad or paper is replaced daily to keep the system operating correctly. For proper operation in high volume or 24-hour stores, the filter pad or paper must be changed twice a day.

If CLOSE DISPOSE VALVE is displayed, close the dispose valve. Press the X button to exit.

NOTICE

The filter pad or paper must be replaced daily.

⚠ WARNING

Do not drain more than one frypot at a time into the built-in filtration unit to avoid overflow and spillage of hot oil that may cause severe burns, slipping and falling.

DISPLAY	ACTION
	<ol style="list-style-type: none"> The fryer MUST be at setpoint temperature. Press the filtration menu button.
	<ol style="list-style-type: none"> Select LEFT VAT or RIGHT VAT for split vats.
	<ol style="list-style-type: none"> Select MAINTENANCE FILTER.
<p>MAINTENANCE FILTRATION?</p>	<ol style="list-style-type: none"> Press the ✓ (check) button to start filtration. If the X button is selected, filtering is cancelled and the fryer resumes normal operation.
<p>WEAR PROTECTIVE GLOVES - PRESS CONFIRM WHEN COMPLETE</p>	<ol style="list-style-type: none"> Press the ✓ (check) button once all personal protection equipment including heat resistant gloves are in place.
<p>ENSURE OIL PAN AND COVER</p>	<ol style="list-style-type: none"> Press the ✓ (check) button if the oil pan and cover are in place.

DISPLAY	ACTION
ARE IN PLACE	
DRAINING IN PROGRESS	7. No action required as oil drains into filter pan.
SCRUB INSIDE VAT AND BETWEEN HEATERS – PRESS CONFIRM WHEN COMPLETE	8. Scrub the vat. If electric clean in between the elements. Press the √ (check) button when complete. <div style="border: 1px solid black; padding: 5px; text-align: center;">⚠ DANGER Keep all items out of drains. Closing actuators may cause damage or injury.</div>
CLEAN SENSORS – PRESS CONFIRM WHEN COMPLETE	9. (Gas Only) Clean the oil level sensor with a no scratch pad (see section 6.6.2 on page 6-5). (All Fryers) Clean around AIF and ATO sensors with a screwdriver or similar object to remove any sediment from around the sensors (see section 6.2.4 on page 6-2) and press the √ (check) button when complete.
WASH VAT?	10. Press the √ (check) button.
WASHING IN PROGRESS	11. No action required while the return valve opens and the vat is flushed with oil from the filter pan.
WASH AGAIN?	12. The filter pump shuts off. If the vat is clean of debris, press the X button to continue. If crumbs are still present, press the √ (check) button and the filter pump runs again. This cycle repeats until the X button is pressed.
RINSING IN PROGRESS	13. No action required while the drain valve closes and the filter pump refills the vat. The drain valve opens and rinses the vat.
RINSE AGAIN?	14. If the vat is clean of debris, press the X button to continue. If an additional rinse is desired, press the √ (check) button and the rinse repeats until the X button is pressed.
POLISH?	15. Press the √ (check) button to continue.
POLISH IN PROGRESS	16. No action required while the drain and return valves are open and oil is pumped through the frypot for five minutes.
FILL VAT?	17. Press the √ (check) button to continue.
FILLING IN PROGRESS	18. No action required while the vat is refilled.
IS VAT FULL?	19. Press the X button to run the pump again if the oil level is below the top oil level full line.* Press the √ (check) button once the oil level is at the top oil level full line. If the vat oil level is not completely filled, check the filter pan to see if most of the oil has returned. The pan may have a small amount of oil. Press the √ (check) button once no oil remains in the filter pan.
	20. The controller switches off.







***NOTE: After a maintenance filtration it is normal to leave some oil in the pan and the level of oil may not return to the level prior to starting maintenance filtration. Answering YES after two attempts at refilling the vat enables auto top off to compensate for any loss of oil during filtration.**

5.3.6 Dispose for Front Dispose Oil Systems

This option is used to dispose of old oil into a front disposal system such as an Itto Can. Front disposal systems use the filter pump to move exhausted oil from the fryer to a quick disconnect connection on the front of the fryer.

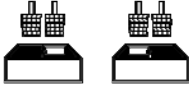

⚠ WARNING

Ensure a filter pad or paper is in place prior to draining or disposing of oil. Failure to insert a filter pad or paper may result in clogged lines and/or pumps.

DISPLAY	ACTION
	1. The fryer MUST be OFF.
	2. Press the filtration menu button
	3. Select LEFT VAT or RIGHT VAT for split vats.
	4. Select DISPOSE OIL.
DISPOSE OIL?	5. Press the ✓ (check) button to continue. If the X button is selected, the user returns to the filtration menu.
DRAINING IN PROGRESS	6. No action required as oil drains into filter pan.
VAT EMPTY?	7. Once the vat is empty, press the ✓ (check) button to continue.
CLEAN VAT COMPLETE?	8. Clean the vat with a scrub brush and when complete press the ✓ (check) button to continue.
IS DISPOSE ATTACHMENT AND CONTAINER IN PLACE? 	9. Attach the dispose attachment and ensure that the METAL disposal can is in place under the discharge nozzle. Press the ✓ (check) button to continue.
OPEN DISPOSE VALVE 	10. Open the left cabinet door and unlock the valve if necessary. Pull the dispose valve completely forward to start disposal.
DISPOSING CLOSE DISPOSE	11. No action is required while the pump transfers the waste oil from the pan to the front dispose container. Close the dispose valve when the





⚠ DANGER

When draining oil into an appropriate METAL container, make sure the container will hold at least FOUR gallons (15 liters) or more, otherwise hot liquid could overflow and cause injury.

DISPLAY	ACTION
VALVE WHEN FULL 	container is full by pushing the valve handle toward the rear of the fryer until it stops. Relock the valve if required by your manager.
REMOVE PAN	12. Carefully pull the filter pan from the fryer. <div style="border: 1px solid black; padding: 5px; text-align: center;"> <p>⚠ DANGER Open the filter pan slowly to avoid splashing of hot oil that may cause severe burns, slipping and falling.</p> </div>
IS PAN EMPTY?	13. If the filter pan is empty press the ✓ (check) button. If the pan is not empty, press the X button and return to step 9 after inserting the filter pan.
INSERT PAN	14. Insert the filter pan.
MANUALLY FILL VAT	15. Carefully pour oil into the vat until it reaches the low level fill line in the fryer. Press the ✓ (check) button once the vat is full.
	16. The controller switches off.

5.3.7 Drain Oil to Pan

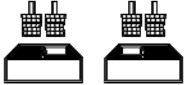



The drain to pan function drains the oil from the vat to the filter pan.



DISPLAY	ACTION
	1. The fryer <u>MUST</u> be OFF.
	2. Press the filtration menu button
	3. Select LEFT VAT or RIGHT VAT for split vats.
	4. Select DRAIN OIL.
DRAIN OIL TO PAN?	5. Press the ✓ (check) button to continue. If the X button is selected, the controller goes to OFF. If no pan is detected, the controller displays ENSURE OIL PAN AND COVER ARE IN PLACE until the pan is detected.
DRAINING IN PROGRESS	6. No action is required while the vat drains the oil into the filter pan.
IS VAT EMPTY?	7. Once the vat is empty, press the ✓ (check) button to continue.
FILL VAT FROM DRAIN PAN?	8. Press the ✓ (check) button to refill the vat, otherwise skip to step 10.

DISPLAY	ACTION
FILLING	9. No action is required while the vat is filling.
IS VAT FULL?	10. Press the X button to run the pump again if the oil level is below the top oil level full line. Press the ✓ (check) button once the vat is full and skip to step 15 to return to OFF.
REMOVE PAN	11. Carefully pull the filter pan from the fryer. <div style="border: 1px solid black; padding: 5px; text-align: center;">⚠ DANGER Open the filter pan slowly to avoid splashing of hot oil that may cause severe burns, slipping and falling.</div>
IS PAN EMPTY?	12. NOTE: A small quantity of oil may remain in the pan after refilling. If the filter pan is empty press the ✓ (check) button and skip to step 12. If the pan is not empty, press the X button and return to FILL VAT FROM DRAIN PAN? in step 7. If the pan is not empty and the fryer is using a bulk oil system, press the X button and continue to step 13.
INSERT PAN	13. Insert the filter pan and skip to step 14 to return to OFF.
PAN TO WASTE?	14. Press the ✓ (check) button to dispose of the oil to the bulk oil waste tanks. Skip to section 5.3.10 OIL PAN TO WASTE step 6.
	15. The controller switches off.

5.3.8 Fill Vat from Drain (Filter) Pan

The drain to pan function drains the oil from the vat to the filter pan.

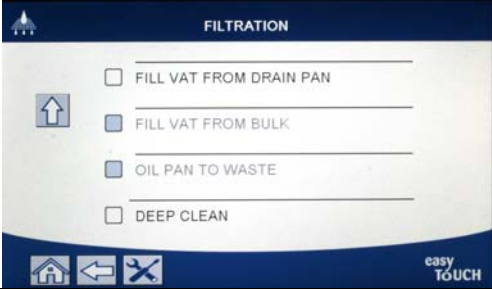
DISPLAY	ACTION
	1. The fryer MUST be OFF.
	2. Press the filtration menu button
	3. Select LEFT VAT or RIGHT VAT for split vats.
 	4. Press the down arrow.

DISPLAY	ACTION
	5. Select FILL VAT FROM DRAIN PAN.
FILL VAT FROM DRAIN PAN?	6. Press the ✓ (check) button to continue. If the X button is selected, the controller goes to OFF. If no pan is detected, the controller displays INSERT PAN until the pan is detected.
FILLING	7. No action is required while the vat is filling.
IS VAT FULL?	8. Press the X button to run the pump again if the oil level is below the top oil level full line. Press the ✓ (check) button once the vat is full and to return to OFF.
	9. The controller switches off.





5.3.13 Deep Clean (Boil-Out) for Front Dispose Oil Systems



The deep clean mode is used to remove carbonized oil from the frypot.

NOTE: Refer to Kay Chemical “Fryer Deep Clean Procedure” instructions to clean the LOV™ fryer.

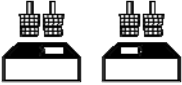
⚠ WARNING

Ensure a filter pad or paper is in place prior to draining or disposing of oil. Failure to insert a filter pad may result in clogged lines and/or pumps.

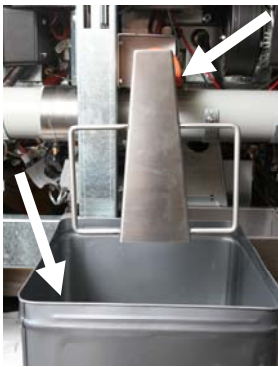
DISPLAY	ACTION
	1. The fryer MUST be OFF.
	2. Press the filtration menu button
	3. Select LEFT VAT or RIGHT VAT for split vats.
 	4. Press the down arrow.

DISPLAY	ACTION
	<p>5. Select DEEP CLEAN.</p>
<p>DEEP CLEAN?</p>	<p>6. Press the ✓ (check) button to continue. If the X button is selected, the user returns to the filtration menu. If no pan is detected, the controller displays INSERT PAN until the pan is detected.</p>
<p>IS VAT OIL REMOVED?</p>	<p>7. Press the X button if oil is in the vat. Press the ✓ (check) button if the vat is empty and skip to step 17.</p>
<p>DRAINING IN PROGRESS</p>	<p>8. No action required as oil drains into filter pan.</p>
<p>VAT EMPTY?</p>	<p>9. Once the vat is empty, press the ✓ (check) button to continue.</p>
<p>CLEAN VAT COMPLETE?</p>	<p>10. Clean the vat with a scrub brush and when complete press the ✓ (check) button to continue.</p>
<p>IS DISPOSE ATTACHMENT AND CONTAINER IN PLACE?</p> 	<p>11. Attach the dispose attachment and ensure that the METAL disposal can is in place under the discharge nozzle. Press the ✓ (check) button to continue.</p> <div style="border: 1px solid black; padding: 5px; text-align: center;"> <p>⚠ DANGER</p> <p>When draining oil into an appropriate METAL container, make sure the container will hold at least FOUR gallons (15 liters) or more, otherwise hot liquid could overflow and cause injury.</p> </div>
<p>OPEN DISPOSE VALVE</p> 	<p>12. Open the left cabinet door and unlock the valve if necessary. Pull the dispose valve completely forward to start disposal.</p>
<p>DISPOSING CLOSE DISPOSE VALVE WHEN FULL</p>	<p>13. No action is required while the pump transfers the waste oil from the pan to the front dispose container. Close the dispose valve when full by pushing the valve handle toward the rear of the fryer until it stops. Relock the valve if required by your manager.</p>

DISPLAY	ACTION
	
REMOVE PAN	<p>14. Carefully pull the filter pan from the fryer.</p> <div style="border: 1px solid black; padding: 5px; text-align: center;"> <p>⚠ DANGER Open the filter pan slowly to avoid splashing of hot oil that may cause severe burns, slipping and falling.</p> </div>
IS PAN EMPTY?	15. If the filter pan is empty press the √ (check) button. If the pan is not empty, press the X button.
INSERT PAN	16. Insert the filter pan. If the pan is empty continue, otherwise and return to step 11.
SOLUTION ADDED?	17. Fill the vat to be cleaned with water and cleaning solution mix. Press the √ (check) button to start the cleaning procedure. Refer to the Deep Clean maintenance requirement card and Kay Chemical provided instructions “Fryer Deep Clean Procedure” for McDonald’s deep clean (boil-out) procedure.
DEEP CLEANING	18. Scrub the vat and then let the solution soak while the vat heats to 195° F (91° C) for one hour.
CLEAN DONE	19. After one hour, the heater shuts off. Press the √ (check) button to silence the alarm.
IS SOLUTION REMOVED?	<p>20. Remove the filter pan and remove crumb basket, hold-down ring, filter pad or paper and screen. Replace empty filter pan in fryer. Refer to Kay Chemical provided instructions “Fryer Deep Clean Procedure” for instructions on the procedure to remove the cleaning solution.</p> <p>Press the √ (check) button once the cleaning solution is removed.</p> <div style="border: 1px solid black; padding: 5px; text-align: center;"> <p>⚠ DANGER Allow deep-clean (boil-out) solution to cool to 100°F (38°C) before disposal, otherwise hot liquid may cause injury.</p> </div>
SCRUB VAT COMPLETE?	21. Press the √ (check) button once the vat is scrubbed.
DRAINING IN PROGRESS	22. No action is required while the vat drains the small amount of residual solution left in the vat.
RINSE COMPLETE?	23. Rinse excess solution from vat. Press the √ (check) button when the vat is completely rinsed.
REMOVE PAN	<p>24. Remove the filter pan and discard any additional fluid. Rinse the pan of any residual solution.</p> <div style="border: 1px solid black; padding: 5px; text-align: center;"> <p>⚠ DANGER Open the filter pan slowly to avoid splashing of hot oil that may cause severe burns, slipping and falling.</p> </div>

DISPLAY	ACTION
VAT AND PAN DRY?	<p>25. Ensure the vat and filter pan are completely dry and press the √ (check) button once complete.</p> <div style="border: 1px solid black; padding: 5px; margin-top: 10px;"> <p style="text-align: center;">⚠ DANGER</p> <p>Ensure that the frypot and filter pan are completely dry and free of water before filling with oil. Failure to do so will cause splattering of hot liquid when the oil is heated to cooking temperature.</p> </div>
INSERT PAN	26. Reinstall screen, filter pad or paper, hold down ring and crumb basket removed in step 20. Insert the filter pan.
MANUALLY FILL VAT	27. Carefully pour oil into the vat until it reaches the low level fill line in the fryer. Press the √ (check) button once the vat is full.
	28. The controller switches off.

BIGLA30-T SERIES GEN III LOV™ GAS FRYER

CHAPTER 6: PREVENTATIVE MAINTENANCE

6.1 Fryer Preventive Maintenance Checks and Service

 **DANGER**

The crumb tray in fryers equipped with a filter system must be emptied into a fireproof container at the end of frying operations each day. Some food particles can spontaneously combust if left soaking in certain shortening material.

 **DANGER**

Never attempt to clean the fryer during the frying process or when the frypot is filled with hot oil. If water comes in contact with oil heated to frying temperature, it will cause spattering of the oil, which can result in severe burns to nearby personnel.

 **WARNING**

Use McDonald's All Purpose Concentrate. Read the directions for use and precautionary statements before use. Particular attention must be paid to the concentration of cleaner and the length of time the cleaner remains on the food-contact surfaces.

6.2 DAILY CHECKS AND SERVICE

6.2.1 Inspect Fryer and Accessories for Damage

Look for loose or frayed wires and cords, leaks, foreign material in frypot or inside cabinet, and any other indications that the fryer and accessories are not ready and safe for operation.

6.2.2 Clean Fryer Cabinet Inside and Out - Daily

Clean inside the fryer cabinet with dry, clean cloth. Wipe all accessible metal surfaces and components to remove accumulations of oil and dust.

Clean the outside of the fryer cabinet with a clean, damp cloth soaked with McDonald's All Purpose Concentrate, removing oil, dust, and lint from the fryer cabinet. Wipe with a clean, damp cloth.

6.2.3 Clean the Built-In Filtration System - Daily

 **WARNING**

Never operate the filter system without oil in the system.

 **WARNING**

Never use the filter pan to transport old oil to the disposal area.

 **WARNING**

Never drain water into the filter pan. Water will damage the filter pump.

There are no periodic preventive maintenance checks and services required for your FootPrint Pro Filtration System other than daily cleaning of the filter pan with a solution of hot water and McDonald's All Purpose Concentrate.

If you notice that the systems is pumping slowly or not at all, verify that the filter pan screen is on the bottom of the filter pan, with the pad on top of the screen. Verify that the two O-ring(s) on the fitting at the right front of the filter pan are present and in good condition.

6.2.4 Clean around AIF and ATO sensors

1. Clean the sediment from around the AIF and ATO sensors during maintenance filtration when the oil is drained from the frypot.
2. Use a screwdriver or other similar object which allows access around the probe (see photo right). Use caution to ensure that the probe is not damaged.
3. Return the oil once the maintenance filtration is complete.



6.3 WEEKLY CHECKS AND SERVICE

6.3.1 Clean Behind Fryers

Clean behind fryers in accordance with the procedure detailed in the maintenance requirement card. Shut off and disconnect the gas. Use the manual gas shut-off valve to shut off the gas supply. The manual gas shut-off valve is located on the supply line before the quick disconnects. Then disconnect the gas line from the fryer via the quick disconnect.

WARNING

To ensure the safe and efficient operation of the fryer and hood, the electrical plug for the 120-volt line, which powers the hood, must be fully engaged and locked in its pin and sleeve socket.

6.3.2 Cleaning the Frypot - Quarterly

DANGER

Never operate the appliance with an empty frypot. The frypot must be filled with water or oil before lighting the burners. Failure to do so will damage the frypot and may cause a fire.

6.3.3 Clean Filter Pan, Detachable Parts and Accessories

As with the frypot, a deposit of carbonized oil will accumulate on the filter pan and detachable parts and accessories such as baskets, sediment trays, or fishplates.

Wipe the filter pan and all detachable parts and accessories with a clean dry cloth. Use a cloth dampened with a solution of McDonald's All Purpose Concentrate to remove accumulated carbonized oil. Rinse and thoroughly dry each part. **DO NOT** use steel wool or abrasive pads to clean these parts. The scratches that result from such scrubbing make subsequent cleanings more difficult.

6.4 BI-WEEKLY CHECKS AND SERVICE

6.4.1 Check M4000 Controller Set Point Accuracy

1. Insert a good-grade thermometer or pyrometer probe into the oil, with the end touching the fryer temperature-sensing probe.
2. When the controller displays "START" (indicating that the frypot contents are within the cooking range),

press the  button once to display the temperature and setpoint of the oil as sensed by the temperature probe.

- Note the temperature on the thermometer or pyrometer. Actual temperature and pyrometer readings should be within $\pm 5^{\circ}\text{F}$ (3°C) of each other. If not, contact a Factory Authorized Servicer for assistance.

6.5 QUARTERLY CHECKS AND SERVICE

6.5.1 Clean Combustion Air Blower Assembly

- Disconnect the blower wiring harness and remove the four blower mounting nuts. (See Figure 1)
- Remove the blower from the fryer cabinet.
- Remove the blower shield or shield assembly.
- Remove the three fasteners that secure the blower motor assembly to the blower housing, and separate the two components. (See Figure 2)

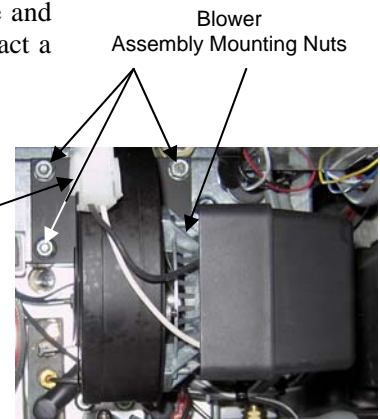

Figure 1

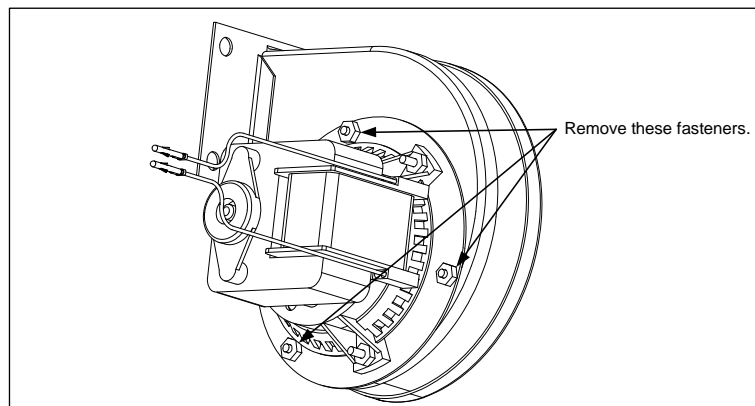

Figure 2

- Wrap the motor with plastic wrap to prevent water from entering it. Spray degreaser or detergent on the blower wheel and the blower housing. Allow it to soak for five minutes. Rinse the wheel and housing with hot tap water, then dry with a clean cloth. (See Figure 3)

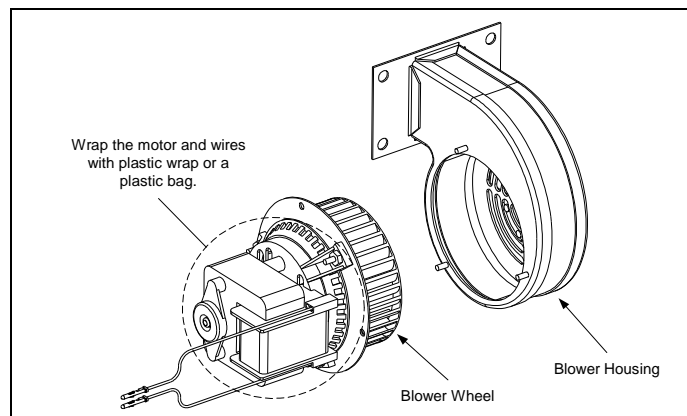

Figure 3

- Remove the plastic wrap from the blower motor assembly. Reassemble the blower motor assembly and blower housing. Reinstall the blower assembly in the fryer.
- Reinstall the blower shield or shield assembly.
- Light the fryer in accordance with the procedure described in Chapter 3, Section 3.1.2.
- After the burners have been lit for at least 90 seconds, observe the flames through the burner viewing ports located on each side of the combustion air blower. (See Figure 4)

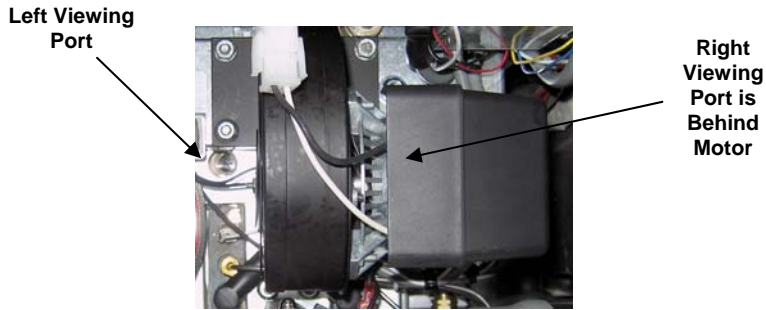
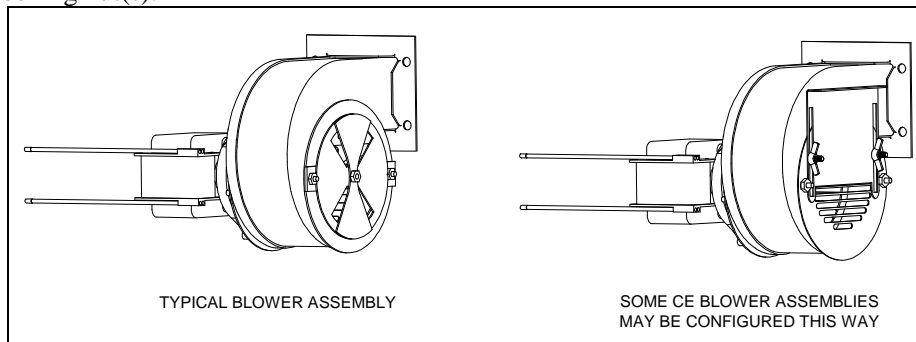

Figure 4

The air/gas mixture is properly adjusted when the burner manifold pressure is in accordance with the applicable table on page 2-4 and the burners display a bright orange-red glow. If a blue flame is observed, or if there are dark spots on a burner face, the air/gas mixture requires adjustment.

On the side of the blower housing opposite the motor is a plate with one or two locking nuts (see illustration on the following page). Loosen the nut(s) enough to allow the plate to be moved, then adjust the position of the plate to open or close the air intake opening until a bright orange-red glow is obtained. Carefully hold the plate in position and tighten the locking nut(s).



6.5.2 Replace the O-rings

Refer to McDonald's MRC cards for specific details on replacing the O-rings on the filter connection.

6.5.3 Deep Clean (Boiling Out) the Frypot

During normal usage of your fryer, a deposit of carbonized oil will gradually form on the inside of the frypot. This film should be periodically removed by following the deep-clean (boil-out) procedure contained in Kay Chemical "Fryer Deep Clean Procedure" instructions. *Refer to pages 5-15 through 5-20 for specific details on setting up the controller for deep clean (boil-out) operation.*

⚠ DANGER

Allow oil to cool to 100°F (38°C) or lower before draining to an appropriate container for disposal.

⚠ WARNING

Never leave the fryer unattended during this process. If the solution overflows, press the ON/OFF switch to the OFF position immediately.

⚠ DANGER

Ensure that the frypot is completely free of water before filling with oil. When the oil is heated to cooking temperature, water in the frypot will cause splattering.

6.5.4 Pre-filter Maintenance

The pre-filter requires regular maintenance. Every 90 days, or more frequently if the flow of oil slows, remove the cap and clean the attached screen.

1. Wearing protective gloves use the supplied wrench to remove the cap from the pre-filter (**Figure 1**).
2. Use a small brush to clear debris from the attached screen (**Figure 2**).
3. Clean under a water tap and thoroughly dry.
4. Return the cap to the pre-filter housing and tighten.



Figure 1



Figure 2

WARNING

DO NOT remove the pre-filter cap when a filter cycle is under way.
DO NOT operate the filter system with the cap removed. Wear protective gloves when handling the cap. The metal and the exposed oil are hot.

6.6 SEMI-ANNUAL CHECKS AND SERVICE

6.6.1 Clean Gas Valve Vent Tube

NOTE: This procedure is not required for fryers configured for export to CE countries.

1. Set the fryer power switch and the gas valve to the OFF position.
2. Carefully unscrew the vent tube from the gas valve. **NOTE:** The vent tube may be straightened for ease in removal.
3. Pass a piece of ordinary binding wire through the tube to remove any obstruction.
4. Remove the wire and blow through the tube to ensure it is clear.
5. Reinstall the tube and bend it so that the opening is pointing downward.

6.6.2 Clean Oil Level Sensor

4. Drain the oil using the drain to pan option in the filter menu.
5. Use a no-scratch pad to clean carbonized oil off of the sensor (see photo right).
6. Return the oil using the fill vat from pan option in the filter menu.



6.7 Annual/Periodic System Inspection

This appliance should be inspected and adjusted periodically by qualified service personnel as part of a regular kitchen maintenance program.

Frymaster recommends that a Factory Authorized Servicer inspect this appliance at least annually as follows:

6.7.1 Fryer

- Inspect the cabinet inside and out, front and rear for excess oil.
- Verify that debris or accumulations of solidified oil do not obstruct the flue opening.
- Verify that burners and associated components (i.e. gas valves, pilot assemblies, ignitors, etc.) are in good condition and functioning properly. Inspect all gas connections for leaks and verify that all connections are properly tightened.
- Verify that the burner manifold pressure is in accordance with that specified on the appliance's rating plate.
- Verify that the temperature and high-limit probes are properly connected, tightened and functioning properly, and that probe guards are present and properly installed.

- Verify that component box components (i.e. controller, transformers, relays, interface boards, etc.) are in good condition and free from oil and other debris. Inspect the component box wiring and verify that connections are tight and that wiring is in good condition.
- Verify that all safety features (i.e. reset switches, etc.) are present and functioning properly.
- Verify that the frypot is in good condition and free of leaks and that the frypot insulation is in serviceable condition.
- Verify that wiring harnesses and connections are tight and in good condition.

6.7.2 Built-In Filtration System

- Inspect all oil-return and drain lines for leaks and verify that all connections are tight.
- Inspect the filter pan for leaks and cleanliness. If there is a large accumulation of crumbs in the crumb basket, advise the owner/operator that the crumb basket should be emptied into a fireproof container and cleaned daily.
- Verify that all O-rings and seals are present and in good condition. Replace O-rings and seals if worn or damaged.
- Check filtration system integrity as follows:
 - Verify that filter pan cover is present and properly installed.
 - With the filter pan empty, place each vat into fill vat from drain pan selection (see section 5.3.8 on page 5-12), one at a time. Verify proper functioning of each oil return valve by activating the filter pump using the fill vat from drain pan selection. Verify that the pump activates and that bubbles appear in the cooking oil of the associated frypot.
 - Verify that the filter pan is properly prepared for filtering, then drain a frypot of oil heated to 350°F (177°C) into the filter pan by using the drain to pan selection (see section 5.3.7 on page 5-11). Now using the fill vat from pan drain pan selection (see section 5.3.8 on page 5-12), allow all oil to return to the frypot (indicated by bubbles in the cooking oil). Press the check button when all oil is returned. The frypot should have refilled in approximately 2 minutes and 30 seconds.

BIGLA30-T SERIES GEN III LOV™ GAS FRYER

CHAPTER 7: OPERATOR TROUBLESHOOTING

7.1 Introduction

This chapter provides an easy reference guide to some of the common problems that may occur during the operation of your equipment. The troubleshooting guides that follow are intended to help you correct, or at least accurately diagnose, problems with your equipment. Although the chapter covers the most common problems reported, you may encounter problems that are not covered. In such instances, the Frymaster Technical Services staff will make every effort to help you identify and resolve the problem.

When troubleshooting a problem, always use a process of elimination starting with the simplest solution and working through to the most complex. Most importantly, always try to establish a clear idea of why a problem has occurred. Part of your corrective action involves taking steps to ensure that it doesn't happen again. If a controller malfunctions because of a poor connection, check all other connections. If a fuse continues to blow, find out why. Always keep in mind that failure of a small component may often be indicative of potential failure or incorrect functioning of a more important component or system.

If you are in doubt as to the proper action to take, do not hesitate to call the Frymaster Technical Service Department or your local Frymaster Factory Authorized Servicer for assistance.

Before calling a servicer or the Frymaster HOTLINE (1-800-551-8633):

- **Verify that electrical cords are plugged in and that circuit breakers are on.**
- **Verify that gas line quick-disconnects are properly connected.**
- **Verify that any gas line cutoff valves are open.**
- **Verify that frypot drain valves are fully closed.**
- **Have your fryer's model and serial numbers ready to give the technician assisting you.**

 **DANGER**

Hot oil will cause severe burns. Never attempt to move this appliance when filled with hot oil or to transfer hot oil from one container to another.

 **DANGER**

This equipment should be unplugged when servicing, except when electrical circuit tests are required. Use extreme care when performing such tests.

This appliance may have more than one electrical power supply connection point. Disconnect all power cords before servicing.

Inspection, testing, and repair of electrical components should be performed by an authorized service agent only.

7.2 Troubleshooting Fryers

7.2.1 Controller and Heating Problems

PROBLEM	PROBABLE CAUSES	CORRECTIVE ACTION
No display on the controller.	A. No power to fryer. B. Failed controller or other component	A. Verify that the fryer is plugged in and that the circuit breaker is not tripped. B. Call your FAS for assistance.
M4000 displays IS VAT FULL? YES NO after a filtration.	A filter error has occurred due to dirty or clogged filter pad or paper, clogged pre-filter, improperly installed filter pan components, worn or missing O-rings, cold oil or filter motor thermal tripped, failed return valve or actuator, failed drain valve or actuator or clogged filter pump.	Follow instructions on the screen to clear the error. See section 5.2 for instructions to change the filter; section 6.5.4 to clean the pre-filter, or 5.3.2 to locate filter motor overload. If problem persists, call your FAS for assistance.
M4000 displays IS DRAIN CLEAR?	Drain is clogged and oil failed to drain.	Clear drain with Fryers Friend and press \checkmark button. Filtration will resume.
M4000 displays CHANGE FILTER PAD?	Filter error has occurred, filter pad or paper clogged, 25 hour filter pad or paper change prompt has occurred or change filter pad or paper was ignored on a prior prompt.	Change the filter pad or paper and ensure the filter pan has been removed from the fryer for a minimum of 30 seconds. Do NOT ignore CHANGE FILTER PAD prompts.
Fryer does not heat.	A. Drain valve not fully closed. B. Gas valve is not turned on. C. Manual gas shut off valve closed. D. Improperly connected quick-disconnect fitting on gas line. E. Obstructed or failed combustion air blower.	A. Check error log. Ensure that E33 is not displayed. B. Turn the gas valve knob to the ON position. C. Verify that any in-line manual shut off and gas main valve is open. D. Verify that the quick-disconnect fitting on the flexible gas line is firmly connected to the fryer. E. Verify that combustion air blower is running. If not, call FAS for service. If combustion air blower is functional, clean and adjust per instructions in Chapter 6 of this manual.
Fryer is operating normally, but recovery is slow when cooking.	Dirty or obstructed combustion air blower.	Clean and adjust per instructions in Chapter 6 of this manual.
Fryer is operating normally, but produces a popping sound when burners ignite.	A. Dirty or obstructed combustion air blower. B. Dirty or obstructed gas valve vent tube (non-CE fryers only). C. Malfunctioning combustion air blower.	A. Clean and adjust per instructions in Chapter 6 of this manual. B. Clean per instructions in Chapter 6 of this manual. C. Call your FAS.
Controller locks up.	Controller error.	Remove and restore power to the controller. If problem persists, call your FAS for assistance.
M4000 displays MISCONFIGURED ENERGY TYPE	Energy type in fryer setup is incorrect.	Ensure that the fryer is configured properly for the correct energy type.
M4000 displays VAT ID CONNECTOR NOT CONNECTED	Controller locator missing or disconnected.	Ensure the 6-pin locator is connected to rear of controller and it properly grounded in control box.

7.2.2 Error Messages and Display Problems

PROBLEM	PROBABLE CAUSES	CORRECTIVE ACTION
M4000 displays E65 CLEAN OIB SENSOR	Dirty OIB (Oil Level) sensor.	Clean the OIB (Oil Level) sensor. See section 6.6.2.
M4000 display OIL SENSOR FAIL.	Oil sensor may have failed.	Call your FAS for assistance.
M4000 displays E19 or E28 HEATING FAILURE.	Gas valve off, failed controller, failed transformer, contactor or open high-limit thermostat.	It is normal for this message to appear during startup if the lines have air in them. Check that the gas valve is on. If the gas is on and it continues shut the fryer down and call your FAS for assistance.
M4000 display shows HOT-HI-1.	Frypot temperature is more than 410°F (210°C) or, in CE countries, 395°F (202°C).	Shut the fryer down immediately and call your FAS for assistance.
M4000 displays RECOVERY FAULT and alarm sounds.	Recovery time exceeded maximum time limit.	Clear error and silence the alarm by pressing the check \checkmark button. Maximum recovery time for gas is 3:15. If the error continues call your FAS for assistance.
M4000 display is in wrong temperature scale (Fahrenheit or Celsius).	Incorrect display option programmed.	Toggle between F° to C° by entering Manager settings, temperature and toggling the temperature scale. Turn the controller on to check temperature. If the desired scale is not displayed, repeat.
M4000 displays HELP HI-2 or HIGH LIMIT FAILURE DISCONNECT POWER.	Failed high limit	Shut the fryer down immediately and call your FAS for assistance.
M4000 displays TEMPRATURE PROBE FAILURE.	Problem with the temperature measuring circuitry including the probe or damaged controller wiring harness or connector.	Shut the fryer down and call your FAS for assistance.
M4000 displays SERVICE REQUIRED followed by an error message.	An error has occurred which requires a service technician.	Press X to continue cooking and call your FAS for assistance. In some cases, cooking may not be allowed.
M4000 displays NO MENU GROUP AVAILABLE FOR SELECTION	All menu groups have been deleted. NOTE: ALL RECIPES is not a group that can be used to cook recipes.	Create a new MENU group. Once a new menu is created, add recipes to the group (see section 4.10).







7.3 Troubleshooting the Auto Filtration

PROBLEM	PROBABLE CAUSES	CORRECTIVE ACTION
Fryer filters after each cook cycle.	Filter after setting incorrect.	Change or overwrite the filter after setting by re-entering the filter after value in Manager Settings, Filter Attributes in section 4.8.

PROBLEM	PROBABLE CAUSES	CORRECTIVE ACTION
MAINTENANCE FILTER won't start.	Temperature too low.	Ensure fryer is at setpoint before starting Maintenance Filter.
M4000 display shows FILTER BUSY.	<ul style="list-style-type: none"> A. Another filtration cycle or filter pad or paper change is still in process. B. Filter interface board has not cleared checking system. 	<ul style="list-style-type: none"> A. Wait until the previous filtration cycle ends to start another filtration cycle. Change filter pad or paper if prompted. B. Wait 15 minutes and try again.
Drain valve or return valve stays open.	<ul style="list-style-type: none"> A. Valve Interface Board has failed. B. Actuator has failed. 	Call your FAS for assistance.
Filter pump won't start or pump stops during filtering.	<ul style="list-style-type: none"> A. Power cord is not plugged in or circuit breaker is tripped. B. Pump motor has overheated causing the thermal overload switch to trip. C. Blockage in filter pump. 	<ul style="list-style-type: none"> A. Verify that the power cord is fully plugged in and the circuit breaker is not tripped. B. If the motor is too hot to touch for more than a few seconds, the thermal overload switch has probably tripped. Allow the motor to cool at least 45 minutes then press the Pump Reset Switch (see page 5-5). C. Call your FAS for assistance.
M4000 displays INSERT PAN.	<ul style="list-style-type: none"> A. Filter pan is not fully set into fryer. B. Missing filter pan magnet. C. Defective filter pan switch. 	<ul style="list-style-type: none"> A. Pull filter pan out and fully reinsert into fryer. Ensure controller does not display P. B. Ensure the filter pan magnet is in place and replace if missing. C. If the filter pan magnet is fully against the switch and controller continues to display INSERT PAN, switch is possibly defective.
Auto filtration won't start.	<ul style="list-style-type: none"> A. Oil level too low. B. Oil temperature is too low. C. Filter Pan out. D. Filtration in recipe settings is set to OFF. E. Filter relay has failed. 	<ul style="list-style-type: none"> A. Ensure oil level is at the top oil fill line (at the top oil level sensor). B. Ensure the oil temperature is at setpoint. C. Ensure controller does not display P. Ensure the filter pan is fully seated into fryer. Power cycle the fryer. D. Set filtration in recipes to ON. E. Call your FAS for assistance.
Filter Pump runs, but oil return is very slow.	<ul style="list-style-type: none"> A. Improperly installed or prepared filter pan components. B. Pre-filter screen may be clogged. 	<ul style="list-style-type: none"> A. Remove the oil from the filter pan and replace the filter pad or paper, ensuring that the filter screen is in place <i>under</i> the pad. Verify, if using a pad, that the rough side is facing up. Verify that O-rings are present and in good condition on filter pan connection fitting. B. Clean pre-filter (see section 6.5.4).

7.3.1 Incomplete Filtration

Should the auto filtration procedure fail an error message is generated. Follow the instructions on the screen to return the oil and clear the error.

DISPLAY	ACTION
IS VAT FULL?	1. Press the √ (check) button if the vat is full to continue. The controller returns to idle cook mode or  . Press X if vat is not filled completely.
FILLING IN PROGRESS	2. No action required as the pump runs.
IS VAT FULL?	3. Press the √ (check) button if the vat is full to continue. The controller returns to idle cook mode or  . Press X if vat is not filled completely.
FILLING IN PROGRESS	4. No action required as the pump runs.
IS VAT FULL?	5. Press the √ (check) button if the vat is full to continue. The controller returns to idle cook mode or  . Press X if vat is not filled completely. If this is the sixth consecutive sequence of incomplete filtration skip to step 10.
CHANGE FILTER PAD?	6. Press the √ (check) button to continue. Pressing X advances to  .
REMOVE PAN	7. Remove the filter pan.
CHANGE FILTER PAD	8. Change the filter pad or paper and ensure the filter pan has been pulled forward, out of the cabinet for at least 30 seconds. Once the pan has been out for 30 seconds the controller returns to idle cook mode. Ensure the pan is dry and assembled correctly. Push the filter pan back into the fryer. Ensure “P” is not displayed on the controller.
IS VAT FULL?	9. Press the √ (check) button if the vat is full to continue. The controller returns to idle cook mode. Press X if vat is not full and the controller advances to  .
SERVICE REQUIRED	10. If a filtration error occurs six consecutive times, the return valve closes. Press the √ (check) button to silence alarm and continue.
ERROR PUMP NOT FILLING	11. The system detects oil is not returning to the vat and service is required. Call an FAS.
SYSTEM ERROR FIXED?	12. Press the X button to continue cooking if possible. Call your FAS to repair and reset the fryer. The error will be re-displayed every 15 minutes until the issue is repaired. Auto filtration and auto top off are disabled until the fryer is reset.
ENTER CODE	13. FAS tech enters tech code to reset fryer.
FILL VAT FROM DRAIN PAN?	14. Press the √ (check) button to fill the vat from filter pan to continue. Follow prompts once the vat is full. Press X to skip filling from drain pan.
REMOVE PAN	15. Remove the filter pan.
IS PAN EMPTY?	16. Press the √ (check) button if the filter pan is empty and continue to next step. Press X to continue filling the vat. Follow the prompts once the vat is full.
	17. The controller switches off.

7.3.2 Clogged Drain Error

The clogged drain error occurs during auto filtration when the oil level sensor detects that oil has not completely drained from the frypot. This may be due to a clogged drain or an oil sensor failure. Follow the instructions on the controller display to clear the error.

When this occurs the controller displays **CLEAR DRAIN** for 15 seconds changing to **IS DRAIN CLEAR?**

1. Clear debris from the drain using the fryer's friend and press the $\sqrt{\quad}$ button to continue.
2. The controller displays **DRAINING**. Once the oil level sensor detects the oil has drained, normal auto filtration operation resumes.

7.3.3 Filter Busy

When **FILTER BUSY** is displayed the filter interface board is waiting on another vat to be filtered or waiting on another function to finish. Wait 15 minutes to see if problem is corrected. If not, call your local FAS.

7.4 Troubleshooting Auto Top Off Issues

PROBLEM	PROBABLE CAUSES	CORRECTIVE ACTION
Frypots top off cold.	Incorrect setpoint.	Ensure setpoint is correct.
One vat doesn't top off.	<ol style="list-style-type: none"> A. Filter error exists. B. Service required error exists C. Solenoid, pump, pin issue, RTD or ATO issue. 	<ol style="list-style-type: none"> A. Clear filter error properly. If problem persists call your FAS for assistance. B. Call your FAS for assistance. C. Call your FAS for assistance.
Frypots won't top off.	<ol style="list-style-type: none"> A. Fryer temperature too low. B. Oil is too cold. C. Yellow top off oil indicator illuminated D. Service required error exists E. Melting unit switch is off (only on solid shortening units) F. Blown fuse. 	<ol style="list-style-type: none"> A. Fryer temperature must be at setpoint. B. Ensure that the oil in the top off reservoir is above 70°F (21°C). C. Ensure the top off reservoir is not out of oil. Replace top off reservoir or fill from bulk and reset top off system. If problem persists call your FAS for assistance. D. Call your FAS for assistance. E. Ensure the switch on the melting unit is in the ON position. F. Check the fuse on the left of the ATO box. If using a solid shortening melting unit, check the fuse below the melting unit switch.

7.5 Troubleshooting Bulk Oil System Problems

PROBLEM	PROBABLE CAUSES	CORRECTIVE ACTION
Top off reservoir won't fill.	<ul style="list-style-type: none"> A. Incorrect setup procedure. B. Another function is in process. C. Dispose valve not completely closed. D. Bulk oil tank is empty. E. Solenoid, pump or switch issue. 	<ul style="list-style-type: none"> A. Power cycle fryer by disconnecting and reconnecting 5-pin bulk oil control power cord on rear of fryer. B. If a filtration or any other filter menu function is in process or FILTER NOW? YES/NO, CONFIRM YES/NO, or SKIM VAT are displayed, wait until the process is complete and try again. C. Ensure the dispose valve handle is pushed fully closed. D. Call your bulk oil provider. E. Call you FAS for assistance.
Top off reservoir or vat filling slow.	<ul style="list-style-type: none"> A. Pump or line issues beyond the scope of operator troubleshooting. 	<ul style="list-style-type: none"> A. Contact your bulk oil provider.
Frypot won't fill.	<ul style="list-style-type: none"> A. Incorrect setup procedure. B. Dispose valve not completely closed. C. Bulk oil tank is empty. D. RTI pump issue. 	<ul style="list-style-type: none"> A. Power cycle fryer by disconnecting and reconnecting 5-pin bulk oil control power cord on rear of fryer. B. Ensure the dispose valve handle is pushed fully closed. C. Call your bulk oil provider. D. Call you FAS for assistance.

7.6 Error Log Codes

See section 4.13.2.1 for instructions to access the Error Log.

Code	ERROR MESSAGE	EXPLANATION
E13	TEMPERATURE PROBE FAILURE	TEMP Probe reading out of range
E16	HIGH LIMIT 1 EXCEEDED	High limit temperature is past more than 410°F (210°C), or in CE countries, 395°F (202°C)
E17	HIGH LIMIT 2 EXCEEDED	High limit switch has opened.
E18	HIGH LIMIT PROBLEM DISCONNECT POWER	Vat temperature exceeds 460°F (238°C) and the high limit has failed to open. Immediately disconnect power to the fryer and call service.
E19	HEATING FAILURE – XXX F or XXX C	Heating Control latch circuit failed. Heat Contactor failed to latch.
E25	HEATING FAILURE - BLOWER	The air pressure switch(s) failed to close.
E27	HEATING FAILURE - PRESSURE SWITCH - CALL SERVICE	The air pressure switch has failed closed.
E28	HEATING FAILURE – XXX F or XXX C	The fryer has failed to ignite and has locked out the ignition module.
E29	TOP OFF PROBE FAILURE - CALL SERVICE	ATO RTD reading out of range
E32	DRAIN VALVE NOT OPEN - FILTRATION AND TOP OFF DISABLED - CALL SERVICE	Drain valve was trying to open and confirmation is missing
E33	DRAIN VALVE NOT CLOSED - FILTRATION AND TOP OFF DISABLED - CALL SERVICE	Drain valve was trying to close and confirmation is missing
E34	RETURN VALVE NOT OPEN - FILTRATION AND TOP OFF DISABLED - CALL SERVICE	Return valve was trying to open and confirmation is missing
E35	RETURN VALVE NOT CLOSED - FILTRATION AND TOP OFF DISABLED - CALL SERVICE	Return valve was trying to close and confirmation is missing

Code	ERROR MESSAGE	EXPLANATION
E36	VALVE INTERFACE BOARD FAILURE - FILTRATION AND TOP OFF DISABLED - CALL SERVICE	Valve Interface Board connections lost or board failure.
E37	AUTOMATIC INTERMITTENT FILTRATION PROBE FAILURE - FILTRATION DISABLED - CALL SERVICE	AIF RTD reading out of range.
E39	CHANGE FILTER PAD	25 hour timer has expired or dirty filter logic has activated.
E41	OIL IN PAN ERROR	The system detects that oil may be present in the filter pan.
E42	CLOGGED DRAIN (Gas)	Vat did not empty during filtration
E43	OIL SENSOR FAILURE - CALL SERVICE	Oil level sensor may have failed.
E44	RECOVERY FAULT	Recovery time exceeded maximum time limit.
E45	RECOVERY FAULT – CALL SERVICE	Recovery time exceeded maximum time limit for two or more cycles.
E46	SYSTEM INTERFACE BOARD 1 MISSING - CALL SERVICE	SIB board 1 connection lost or board failure.
E51	DUPLICATE BOARD ID - CALL SERVICE	Two or more controllers have the same location ID.
E52	USER INTERFACE CONTROLLER ERROR - CALL SERVICE	The controller has an unknown error.
E53	CAN BUS ERROR - CALL SERVICE	Communications are lost between boards.
E54	USB ERROR	USB connection lost during an update.
E55	SYSTEM INTERFACE BOARD 2 MISSING - CALL SERVICE	SIB board 2 connection lost or board failure.
E61	MISCONFIGURED ENERGY TYPE	The fryer is configured for the incorrect energy type.
E62	VAT NOT HEATING – CHECK ENERGY SOURCE – XXXF OR XXXC	The vat is not heating properly.
E63	RATE OF RISE	Rate of rise error occurred during a recovery test.
E64	FILTRATION INTERFACE BOARD FAILURE - FILTRATION AND TOP OFF DISABLED - CALL SERVICE	Filtration Interface Board connections lost or board failure.
E65	CLEAN OIB SENSOR – XXX F OR XXX C - CALL SERVICE	Gas -The oil is back sensor does not detect oil. Clean oil sensor (see section 6.6.2).
E66	DRAIN VALVE OPEN – XXXF OR XXXC	Drain valve is opened during cooking.
E67	SYSTEM INTERFACE BOARD NOT CONFIGURED - CALL SERVICE	Controller is turned on when the SIB board is not configured.
E68	OIB FUSE TRIPPED – CALL SERVICE	The VIB board OIB fuse has tripped and didn't reset.
E69	RECIPES NOT AVAILABLE – CALL SERVICE	The controller has not been programmed with product recipes. Replace controller with factory programmed controller.

BIGLA30-T SERIES GEN III LOV™ GAS FRYER

APPENDIX D: Itto Solid Shortening Installation Option

1. Open right door of fryer and remove brace in oil reservoir cabinet.
2. Position melting unit in front of cabinet as shown in Figure 1.
3. Slide the melting unit into the cabinet ensuring the pickup assembly is in front of the heater unit as shown in Figure 2.
4. Carefully maneuver the female pickup tube assembly onto the four studs of the upright heater plate assembly, ensuring that all four studs are completely through all the holes prior to tightening the nuts.
5. Connect the female pickup assembly using the four provided nuts with a 7/16" socket as shown in Figure 3.
6. Use the provided six Phillips head screws to attach the melting unit to the bottom of the interior rails on both sides using the existing holes as shown in Figure 4.
7. Locate the female two-pin connection to the right of the FIB box assembly and the two pin male connection on the rear of the melting unit as shown in Figure 5.
8. Attach the connection to the male two pin connection on the rear of the melting unit as shown in Figure 6.
9. Place the harness into the tie strap on the rear of the heater assembly to protect the harness from damage.
10. Place the melting unit lid on an Itto can and slide the oil pickup tube nipple into the female suction receptacle in the rear of the cabinet. See Figure 7.
11. Lift and close the front of the melting unit. See Figure 8.
12. Ensure the melting unit power switch is in the "ON" position. See Figure 8.



Figure 1: Position melting unit in front of cabinet.



Figure 2: Slide the melting unit in the cabinet.

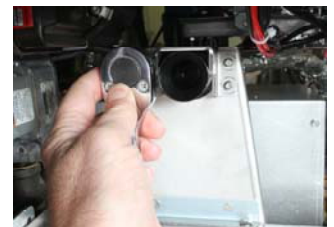

Figure 3: Attach the suction assembly to the melting unit.



Figure 6: Attach the connections.



Figure 4: Attach the melting unit to the rails using the six Phillips head screws.



Figure 5: Locate the two pin connections.



Figure 7: Place top on Itto can and slide into female suction assembly in the rear of the cabinet.



Figure 8: The assembled melting unit is shown in position.

BIGLA30-T SERIES GEN III LOV™ GAS FRYER

APPENDIX E: Itto Solid Shortening Melting Unit Use

1. Ensure shortening melting unit is on (see Figure 1).
2. Slide up and drop down the front cover (see Figure 2).
3. Slide out the empty Itto can from the fryer if present (see Figure 3).
4. Lift off the suction lid assembly and wash, rinse and sanitize (see Figure 4). Dry with paper towels.
5. Remove the empty Itto can. Clean the holding tray using paper towels and KAY Heavy Duty Degreaser every can change or at a minimum, weekly.
6. Remove lid from new Itto can and lower suction lid into the shortening (see Figure 5).
7. Replace the container in the fryer (see Figure 6).
8. Replace the front cover lowered in step 2.
9. Press the orange reset button to turn off the indicator and reset the top off system. A top off delay (programmable in ATO Delay Time) defaults to 30 minutes, which suppresses top off and allows time for the solid shortening to melt. The low oil reservoir indicator will come on if the fryer calls for oil before the shortening in the melting unit is liquid.
10. For best results, **DO NOT TURN OFF** the solid shortening melting switch overnight.
11. The power switch for the melting unit is also used as a reset switch if the system's high limit temperature is reached.

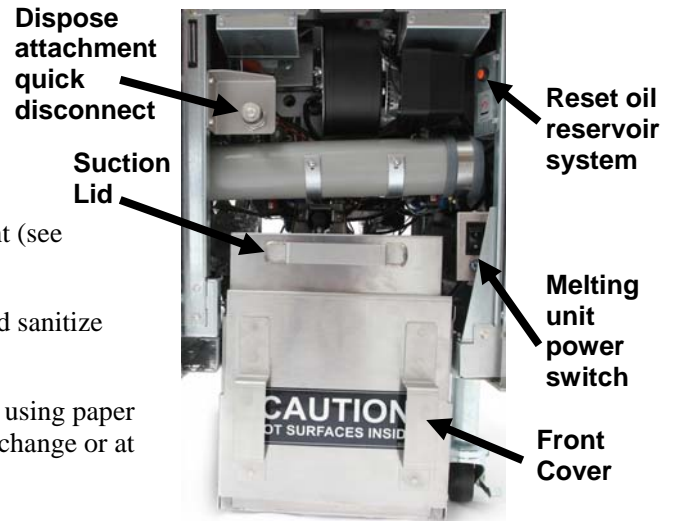

Figure 1



Figure 2



Figure 3



Figure 4



Figure 5



Figure 6

⚠ WARNING

The surfaces of the solid shortening heater are hot. Do not touch with bare hands. Wear protective clothing when changing the shortening.

THIS PAGE INTENTIONALLY LEFT BLANK



FRYMASTER
8700 LINE AVENUE, SHREVEPORT, LA 71106-6800

318-865-1711
844-724-CARE (2273)
WWW.FRYMASTER.COM
EMAIL: FRYSERVICE@WELBILT.COM



Every new piece of Welbilt equipment comes with KitchenCare™ and you choose the level of service that meets your operational needs from one restaurant to multiple locations.

StarCare – Warranty & lifetime service, certified OEM parts, global parts inventory, performance audited

ExtraCare – CareCode, 24/7 Support, online/mobile product information

LifeCare – Install & equipment orientation, planned maintenance, KitchenConnect™, MenuConnect

Talk with KitchenCare™ - 1-844-724-CARE - www.mtwkitchencare.com

To learn how Welbilt and its leading brands can equip you, visit our global web site at www.welbilt.com, then discover the regional or local resources available to you.

